

NUCLEO



HOME COLLECTION
2025 / 2026

Tables - Cofee Tables - Chairs - Consolle

CALLA

Art. 00-20 pag. 31

Base Ø 100 Bianco Bucciato

Piano tavolo Ø120 CM

marmo Travertino Classico Opaco (M3)

Sedie Willow struttura in legno Rovere

seduta e schienale cat.A cod.788-315

Madia Madrid Castagno Naturale

ripiano in gres travertino opaco



DAHALIA

Art. 00-15 pag. 28

Base Ø 80 in Bronzo Metallizzato

Piano tavolo Ø 130 cm

marmo naturale Arabescato (M4)

Sedie Medlar scocca in legno nero
seduta e schienale cat. B cod.786-001



DAISY

Art. 00-25 pag. 34

Base Ø 60 Bianco Bucciato

Piano tavolo Ø130 CM

marmo naturale Bianco Carrara (M1)

sedia Mimosa_B scocca bianco bucciato

seduta legno Bianco



TULIPANO

Art. 00-10 pag. 13

Base Tulipano bianco lucido Ø 50 cm

Piano tavolo Ø 160 cm

marmo naturale Bianco Carrara opaco (M1)

Sedie tulipano Nylon bianco lucido

cuscino in tessuto cat.V serie Adone cod.TM070_20

Tavolino Tulipano bianco lucido Ø 43 cm

Piano tavolino Ø 50 cm

marmo naturale Bianco Carrara opaco (M1)



IRIS

Art. 00-30 pag. 37

Base doppia Ø 81.7 nero bucciato

Piano tavolo 240x110 cm

gres Calacatta Oro (C2)

Sedie Cypress B scocca in bronzo metallizzato
seduta e schienale in tessuto cat.A cod.788-409



CLOVER

Art. 00-30 pag. 40

Base Ø 60 cm nero bucciato

Piano tavolo Ø 140 cm

marmo naturale Calacatta (M4)

Sedie Ginger scocca in nero bucciato
seduta e schienale in legno nero



ROOT

Art. 00-30 pag. 49

Base 101.5x45.5 cm in legno naturale

Piano tavolo 200x100 cm

marmo naturale Emperador (M2)

Sedie Maple scocca in legno naturale

seduta e schienale in tessuto cat.B cod.787-002

Consolle Londra in legno naturale

ripiani in marmo naturale Emperador (M2)



CLOVER WOOD

Art. 00-30 pag. 43

Base Ø102.5 in legno noce chiaro

Piano tavolo Ø 160 cm

marmo naturale Breccia Rosa (M3)

Sedie Willow scozza in legno noce chiaro

seduta e schienale in tessuto cat.B cod.784-615



SQUARE

Art. 00-30 pag. 52

Base 180x90 cm in nero bucciato

Piano tavolo 190x110 cm

Gres materico Pietra di Cardoso Nero (C3)

Sedie Cypress scocca nero bucciato

seduta e schienale in tessuto cat.A cod.788-409



STEM

Art. 00-30 pag. 46

Base Ø 53 cm in legno noce scuro

Piano tavolo Ø 150 cm

marmo naturale nero marquinia (M2)

Sedie Maple scocca nero bucciato

seduta e schienale in tessuto cat.B cod. 787-003



BRAND	pag. 4
CATALOGO CATALOGUE	pag. 7
TULIPANO	pag. 13
TAVOLI FISSI FIXED TABLES	pag. 27
TAVOLI ALLUNGABILI EXTENDABLE TABLES	pag. 55
CONSOLLE CONSOLLE	pag. 65
TAVOLINI COFFEE TABLES	pag. 91
SEDIE CHAIRS	pag. 121
FINITURE FINISHES	pag. 133
• MATERIALI PER TOP TAVOLO TABLETOP MATERIALS	
• MATERIALI E COLORI PER TAVOLI E SEDIE MATERIAL AND COLOR FOR TABLE AND CHAIRS	
• PROFILI TOP TAVOLO TABLETOP EDGES	
LISTINI TOP TOP PRICE LIST	pag. 153
• TOP TAVOLI MARMO - CERAMICA - QUARZO - AGG. TERRAZZO TABLE TOP MARBLE - CERAMIC - QUARTZ - AGG. TERRAZZO	
• CORNICI TAVOLI FRAMES TABLES	
CURA E MANUTENZIONE CARE AND MAINTENANCE	pag. 157
NOTE	pag. 157

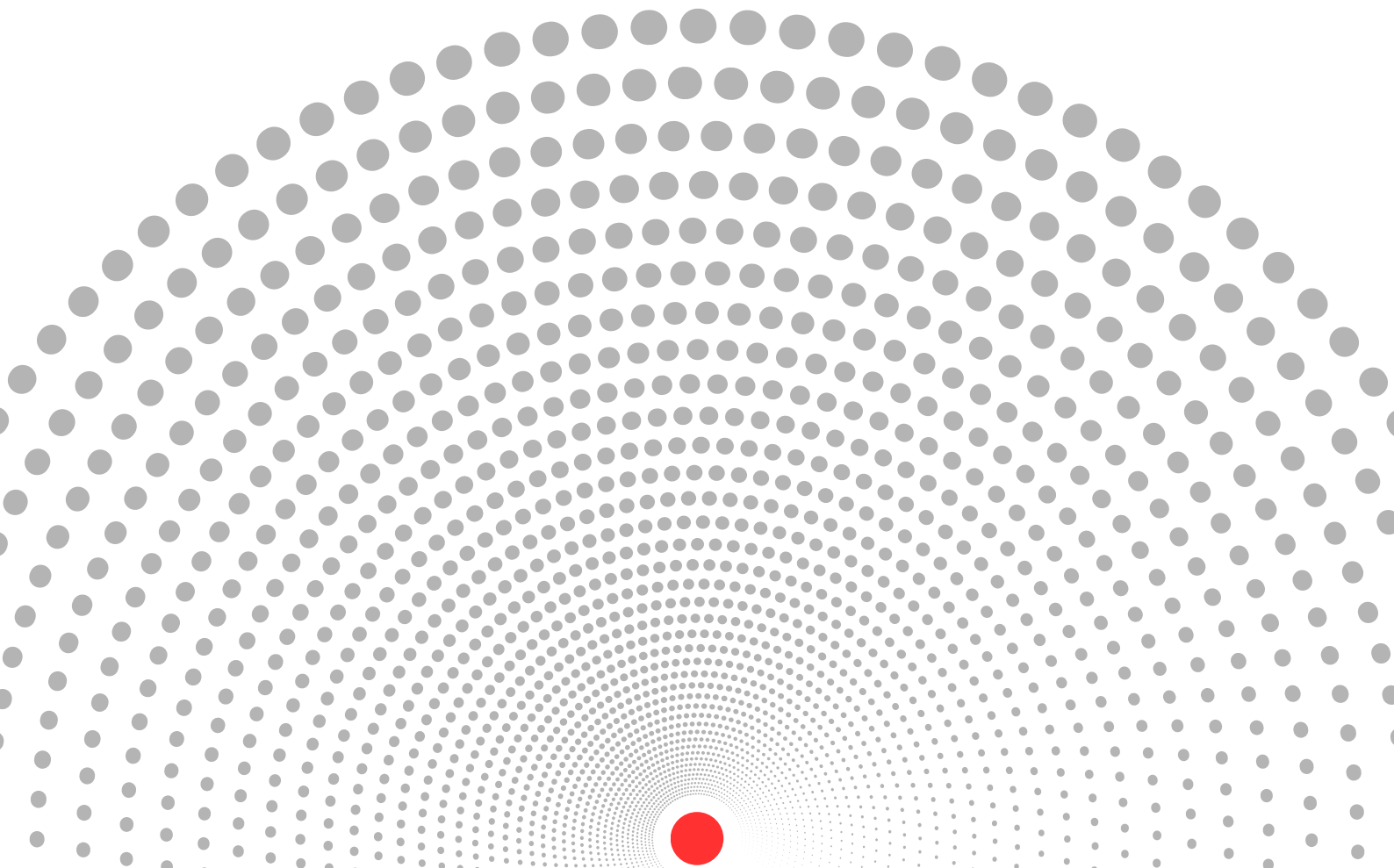

Nucleo

Brand

2025

Su di noi

About us

NUCLEO è il nuovo brand che entra a far parte del gruppo Serra marmi, avvalendosi delle capacità produttive ed organizzative dell'azienda gestita interamente e direttamente dalla famiglia Serra che, da tre generazioni, produce e fornisce i più importanti brand di arredo e design.

La nostra esperienza ci permette di rimanere sempre al passo delle mode ed al tempo stesso di creare personalizzazioni grazie alla vastità di colori disponibili e la possibilità di realizzare pezzi unici su misura forti della nostra produzione interna.



NUCLEO is the new brand that joins the Serra marmi group, taking advantage of the production and organizational capabilities of the company managed entirely and directly by the Serra family which has been producing and supplying the most important furniture and design brands for three generations. Our experience allows us to always keep up with fashion trends and at the same time create customizations thanks to the vastness of available colors and the possibility of creating unique tailor-made pieces thanks to our internal production.

Il Brand Nucleo..perché?

Desideriamo creare bellezza personalizzata per rispondere ai gusti di tutti.

Avrete così l'opportunità di vivere e presentare il Vostro oggetto al CENTRO del Vostro spazio, grazie alla nostra ricerca nel design e alla possibilità di personalizzarlo per forma, colore e dimensione.



Nucleo..why?

We want to create personalized beauty to suit everyone's tastes.

You will have the opportunity to live and present your object at the CENTER of your space, thanks to our research in design and the possibility of customizing it in shape, color and size.





Nucleo

Catalogo

Catalogue

2025

TAVOLI

TABLES



Tulipano
pag. 13



Clover
pag. 40



Dahlia
pag. 28



Clover Wood
pag. 43



Calla
pag. 31



Stem
pag. 45



Daisy
pag. 34



Root
pag. 49



Iris
pag. 37



Square
pag. 52

TAVOLI ALLUNGABILI

EXTENDABLE TABLES



Summer
pag. 56



Falcon
pag. 58



Spring
pag. 60



Eagle
pag. 62

MADIE - CONSOLLE

SIDEBOARDS - CONSOLE TABLES



Madrid
pag. 66



Parigi
pag. 74



Vienna
pag. 78



Londra
pag. 81



Berlino
pag. 86

TAVOLINI

COFFEE TABLES



Tulipano
pag. 18



Rose
pag. 102



Dahlia B
pag. 92



Leaf
pag. 104



Calla B
pag. 94



Stone
pag. 108



Iris B
pag. 96



Cube
pag. 111



Stem B
pag. 98



Corner
pag. 113



Violet
pag. 100



Trendy
pag. 117

SEDIE CHAIRS



Tulipano

pag. 19 - 20



Willow

pag. 127



Maple

pag. 122 - 123



Medlar

pag. 127



Pine

pag. 123



Cypress

pag. 128 - 129



Poplar

pag. 124 - 125



Mimosa

pag. 130 - 131



Palm

pag. 126



Ginger

pag. 131



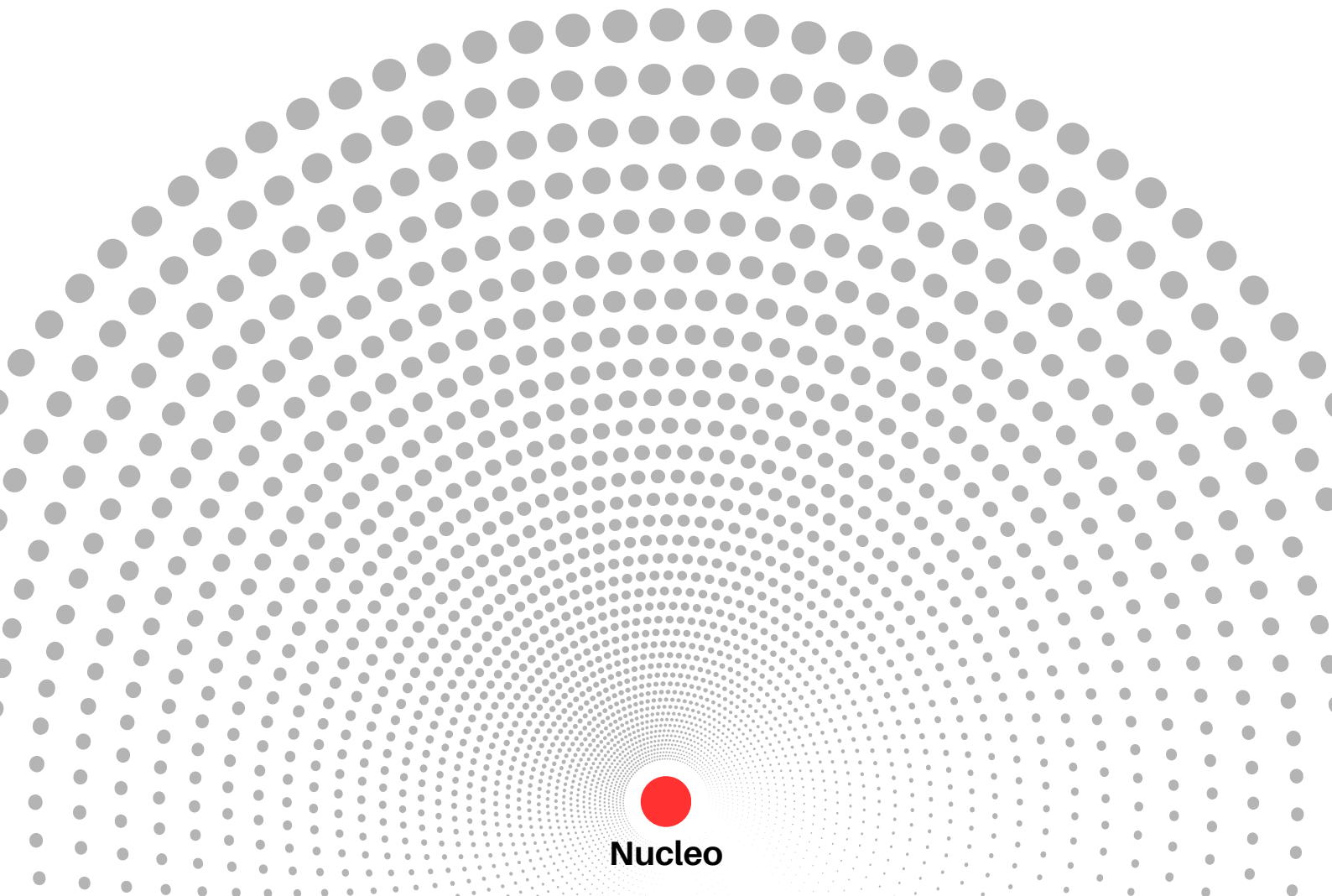

Nucleo

Tulipano

2025



TULIPANO

Art. 00-10

Icona del design, innovativo nella forma elegante e raffinata. Un tavolo che è un elemento di eccezionale praticità e bellezza, ovale o tondo, da utilizzare come tavolo da pranzo, soggiorno o coffee table, con un'unica base centrale che libera lo spazio circostante.

Icon of design, innovative in its elegant and refined form. A table that is an element of exceptional practicality and beauty, oval or round, to be used as a dining table, living room or coffee table, with a single central base that frees up the surrounding space.

COLORE STRUTTURA STANDARD - STANDARD STRUCTURE COLOR

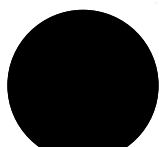

Nero
Lucido

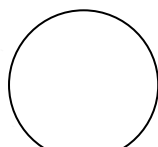

Bianco
Lucido

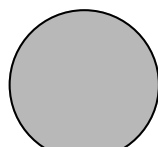

Grigio
Opaco

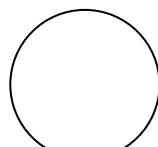

Bianco
Opaco

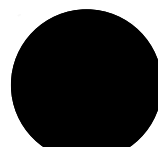

Nero
Opaco



TULIPANO

Art. 00-10-01**€ 780,00**

Base \varnothing 43 cm
 Struttura in fusione unica alta 71 cm per tavolo fisso
 Colore standard
 Top tavolo escluso

Base \varnothing 43 cm
 Single cast structure 71 cm high for fixed table
 Standard color
 Table top not included

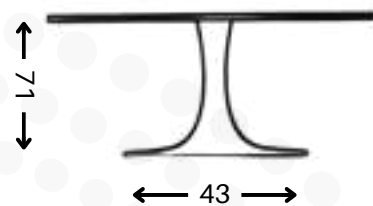
Forme e dimensioni top possibili**Art. 00-10-02****€ 1.011,00**

Base \varnothing 50 cm
 Struttura in fusione unica alta 71 cm per tavolo fisso
 Colore standard
 Top tavolo escluso

Base \varnothing 50 cm
 Single cast structure 71 cm high for fixed table
 Standard color
 Table top not included

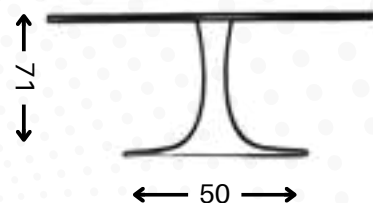
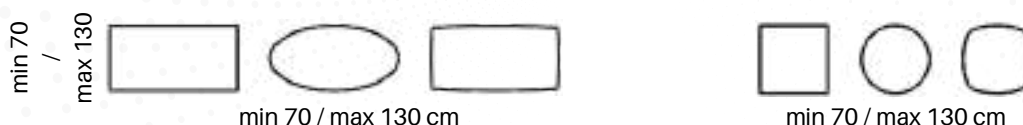
Forme e dimensioni top possibili**Art. 00-10-03****€ 1.569,00**

Base \varnothing 70 cm
 Struttura in fusione unica alta 71 cm per tavolo fisso
 Colore standard
 Top tavolo escluso

Base \varnothing 70 cm
 Single cast structure 71 cm high for fixed table
 Standard color
 Table top not included

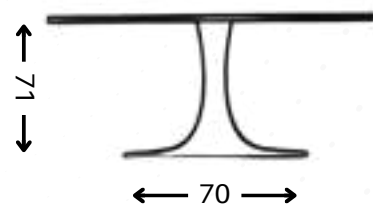
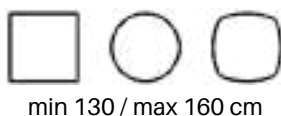
Forme e dimensioni top possibili

Art. 00-10-04**€ 1.831,00**Base ovale **79x59 cm**Struttura in fusione unica alta **71 cm** per tavolo fisso

Colore standard

Top tavolo escluso

Oval base **79x59 cm**Single cast structure **71 cm** high for fixed table

Standard color

Table top not included

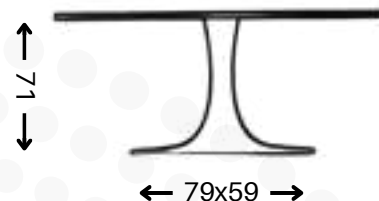
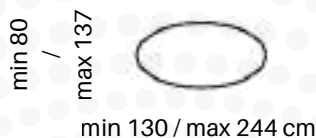
Forme e dimensioni top possibili**Art. 00-10-05****€ 3.787,00**Base ovale **100x75 cm**Struttura in fusione unica alta **71 cm** per tavolo fisso

Colore standard

Top tavolo escluso

Oval base **100x75 cm**Single cast structure **71 cm** high for fixed table

Standard color

Table top not included

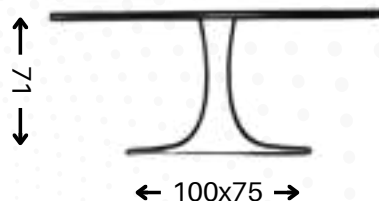
Forme e dimensioni top possibili

Art. 10-10-01**€ 672,00**Base **Ø 43 cm**Struttura in fusione unica alta **39 cm** per tavolo fisso

Colore standard

Top tavolo escluso

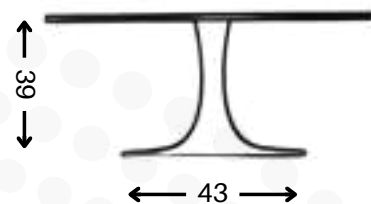
Base **Ø 43 cm**Single cast structure **39 cm** high for fixed table

Standard color

Table top not included

Forme e dimensioni top possibili

min 60 / max 90 cm

Art. 10-10-02**€ 749,00**Base ovale **56x41 cm**Struttura in fusione unica alta **39 cm** per tavolo fisso

Colore standard

Top tavolo escluso

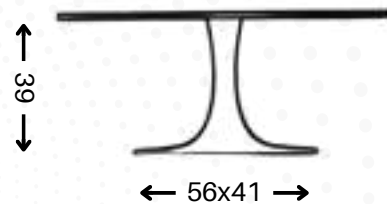
Oval base **56x41 cm**Single cast structure **39 cm** high for fixed table

Standard color

Table top not included

Forme e dimensioni top possibili

min 100 / max 120 cm

Tulipano FiberGlass

art. 20-10-01

Sedia con basamento rotondo in fusione di alluminio laccato lucido o opaco, scocca in vetroresina con cuscino schiumato.

Chair with round base in glossy or matt lacquered cast aluminium, fiberglass shell with foam cushion.



Tessuti Seduta cat. T e cat. ECO
Seat Fabrics cat. T e cat. ECO

€ 1.260,00

Tessuti Seduta cat. V
Seat Fabrics cat. V

€ 1270,00

Tessuti Seduta cat. PA
Seat Fabrics cat. PA

€ 1.364,00

Scegli il tuo stile - Choose your style

Colori Struttura - standard Tulipano

Structure Colors - standard Tulipano.....pag. 21

Colori Seduta - sedie Tulipano

Seat Colors - Chair Tulipano.....pag. 22 -26



Tulipano Nylon

art. 20-10-02

Sedia con basamento rotondo in fusione di alluminio laccato lucido o opaco, scocca in nylon con cuscino schiumato.

Chair with round base in glossy or matt lacquered cast aluminium, nylon shell with foam cushion.

Tessuti Seduta cat. T e cat. ECO
Seat Fabrics cat. T e cat. ECO

€
973,00

Tessuti Seduta cat. V
Seat Fabrics cat. V

€
983,00

Tessuti Seduta cat. PA
Seat Fabrics cat. PA

€ 1.079,00

Scegli il tuo stile - Choose your style

Colori Struttura - standard Tulipano

Structure Colors - standard Tulipano.....pag. 21

Colori Seduta - sedie Tulipano

Seat Colors - Chair Tulipano.....pag. 22 - 26

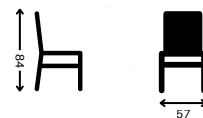



Tulipano Chair B

art. 20-10-03

Sedia con basamento rotondo in fusione di alluminio laccato lucido o opaco, scocca in vetroresina con schienale rivestito in tessuto e cuscino schiumato.

Chair with round base in gloss or matt lacquered cast aluminum, fiberglass shell with backrest covered in fabric and foamed cushion.

Tessuti Seduta cat. T
Seat Fabrics cat. T **€ 1.524,00**

Tessuti Seduta cat. V
Seat Fabrics cat. V **€ 1.534,00**

Tessuti Seduta cat. PA
Seat Fabrics cat. PA **€ 1.919,00**

Scegli il tuo stile - Choose your style

Colori Struttura - standard Tulipano
Structure Colors - standard Tulipano.....pag. 21

Colori Seduta - sedie Tulipano
Seat Colors - Chair Tulipano.....pag. 22 - 26



Tulipano Armchair

art. 20-10-04

Poltrona con basamento rotondo in fusione di alluminio laccato lucido o opaco, scocca in vetroresina con cuscino schiumato.

Armchair with round base in gloss or matt lacquered cast aluminum, fiberglass shell with foamed cushion.

Tessuti Seduta cat. T cat. ECO
Seat Fabrics cat. T e cat. ECO **€ 1.472,00**

Tessuti Seduta cat. V
Seat Fabrics cat. V **€ 1.482,00**

Tessuti Seduta cat. PA
Seat Fabrics cat. PA **€ 1.641,00**

Scegli il tuo stile - Choose your style

Colori Struttura - standard Tulipano
Structure Colors - standard Tulipano.....pag. 21

Colori Seduta - sedie Tulipano
Seat Colors - Chair Tulipano.....pag. 22 - 26

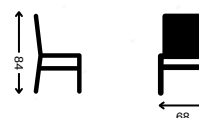

Finiture Tulipano

Strutture Tavoli e Sedute
Tables Structures and Chairs

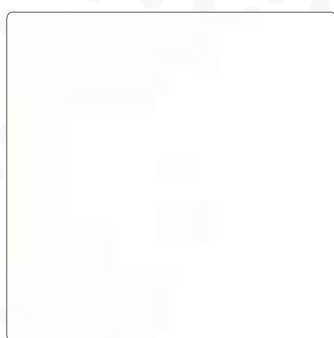

Bianco Opaco 01
White Matt 01

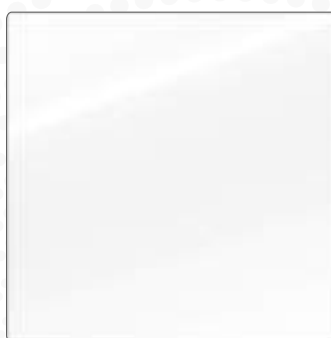

Bianco Lucido 02
White Glossy 02



Nero Opaco 03
Black Matt 03

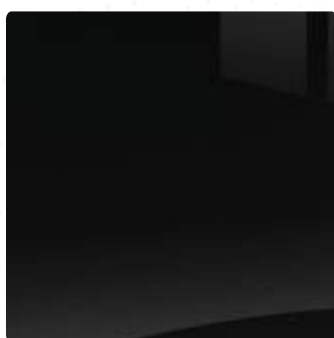

Nero Lucido 04
Black Glossy 04



Grigio Opaco 05
Grey Matt 05

Per le sedie il piede è disponibile in tutte le finiture, la scocca in nylon solo in Bianco Lucido, mentre la scocca in vetroresina solo in Bianco Opaco o Nero Opaco.

For the chairs the foot is available in all finishes, the nylon shell only in Glossy White, while the fiberglass shell only in Matt White or Matt Black.

Cat. T - Tessuti Sedie modello Tulipano serie JET

Cat. T - Fabrics Chairs model Tulipano series JET



Cat. T - Tessuti Sedie modello Tulipano serie MAYA

Cat. T - Fabrics Chairs model Tulipano series MAYA



Cat. PA - Pelle Sedie modello Tulipano serie SUAVE

Cat. PA - Leather Chairs model Tulipano series SUAVE



Cat. PA - Pelle Sedie modello Tulipano serie KELLY

Cat. PA - Leather Chairs model Tulipano series KELLY



Cat. ECO - Similpelle Ignifuga Sedie modello Tulipano serie TOUCH

Cat. ECO - Fireproof Faux Leather Chairs model Tulipano series TOUCH

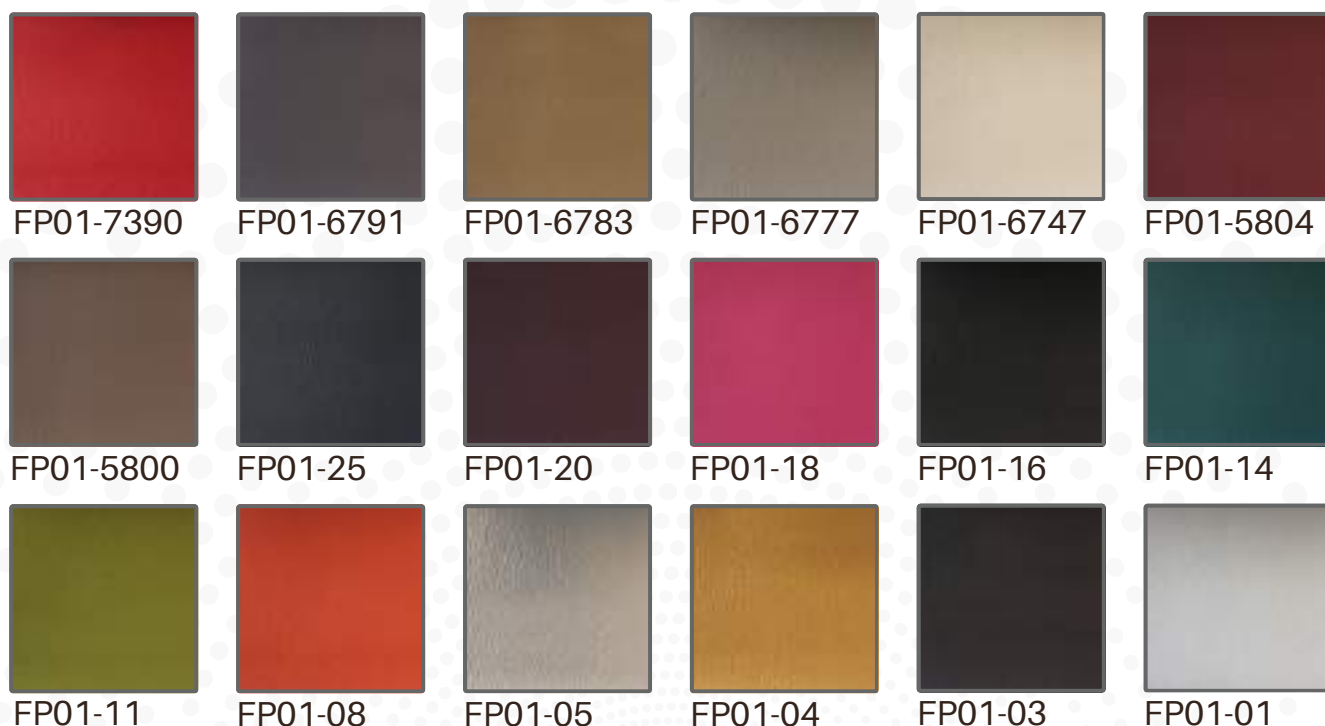

Cat. V - Velluto Sedie modello Tulipano serie ADONE

Cat. V - Velvet Chairs model Tulipano series ADONE





Nucleo

Tavoli Fissi

Fixed Tables

2025



DAHALIA

Art. 00-15

La struttura circolare in acciaio e le curve armoniose degli archi conferiscono un tocco di eleganza a questo tavolo, adattandosi a qualsiasi ambiente e creando uno stile raffinato e moderno.

The circular steel structure and the harmonious curves of the arches give a touch of elegance to this table, adapting to any environment and creating a refined and modern style.

COLORE STRUTTURA STANDARD - STANDARD STRUCTURE COLOR



Bronzo
Metallizzato



Rame
Metallizzato



Alluminio
Goffrato



Avorio
Opaco



Beige
Grigio

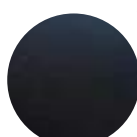

Nero
Bucciato



Bianco
Bucciato

Art. 00-15-01**€ 1.405,00**

Base **Ø 80 cm** con massima apertura **Ø 105 cm**
 Struttura in acciaio alta **74 cm** per tavolo fisso
 Colore standard
 Top tavolo escluso

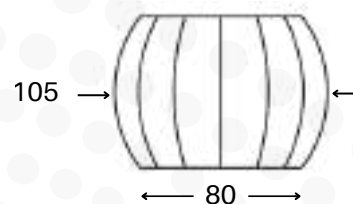

Base **Ø 80 cm** with maximum opening **Ø 105 cm**
 Steel structure **74 cm** high for fixed table
 Standard color
 Table top not included

Forme e dimensioni top possibili**Art. 00-15-02****€ 1.738,00**

Base **Ø 100 cm** con massima apertura **Ø 125 cm**
 Struttura in acciaio alta **74 cm** per tavolo fisso
 Colore standard
 Top tavolo escluso

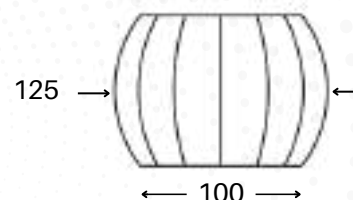

Base **Ø 100 cm** with maximum opening **Ø 125 cm**
 Steel structure **74 cm** high for fixed table
 Standard color
 Table top not included

Forme e dimensioni top possibili

FINITURE TOP TAVOLO PAG. 133 - PREZZI TOP TAVOLO PAG. 153
 TABLE TOP FINISHES PAG. 133 - TABLE TOP PRICES PAG. 153



DAHALLIA



CALLA

Art. 00-20

Questo tavolo moderno e contemporaneo in acciaio sfrutta le forme per creare un intreccio di ombre e linee vuote che riempiono l'ambiente.

This modern and contemporary steel table uses shapes to create a weave of shadows and empty lines that fill the space.

COLORE STRUTTURA STANDARD - STANDARD STRUCTURE COLOR



Bronzo
Metallizzato



Rame
Metallizzato



Alluminio
Goffrato



Avorio
Opaco



Beige
Grigio

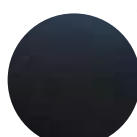

Nero
Bucciato



Bianco
Bucciato

Art. 00-20-01**€ 1.476,00**

Base **Ø 80 cm** con minima apertura **Ø 40 cm**
 Struttura in acciaio alta **74 cm** per tavolo fisso
 Colore standard
 Top tavolo escluso

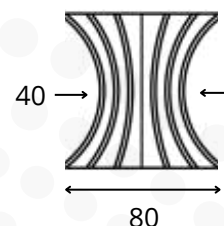

Base **Ø 80 cm** with minimum opening **Ø 40 cm**
 Steel structure **74 cm** high for fixed table
 Standard color
 Table top not included

Forme e dimensioni top possibili**Art. 00-20-02****€ 1.898,00**

Base **Ø 100 cm** con minima apertura **Ø 50 cm**
 Struttura in acciaio alta **74 cm** per tavolo fisso
 Colore standard
 Top tavolo escluso

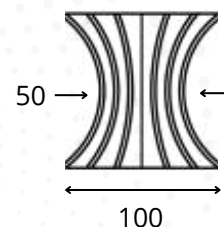

Base **Ø 100 cm** with minimum opening **Ø 50 cm**
 Steel structure **74 cm** high for fixed table
 Standard color
 Table top not included

Forme e dimensioni top possibili

FINITURE TOP TAVOLO PAG. 133 - PREZZI TOP TAVOLO PAG. 153
 TABLE TOP FINISHES PAG. 133 - TABLE TOP PRICES PAG. 153



CALLA



DAISY

Art. 00-25

Questo tavolo minimalista è un mix di semplicità e modernità. Una solida ma armoniosa struttura in acciaio sostiene un piano che diventa il fulcro dell'intero design.

This minimalist table is a mix of simplicity and modernity. A solid but harmonious steel structure supports a top that becomes the centerpiece of the entire design.

COLORE STRUTTURA STANDARD - STANDARD STRUCTURE COLOR



Bronzo
Metallizzato



Rame
Metallizzato



Alluminio
Goffrato



Avorio
Opaco



Beige
Grigio

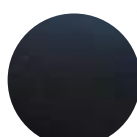

Nero
Bucciato



Bianco
Bucciato

Art. 00-25-01**€ 585,00**

Base **Ø 60 cm** con minima apertura **Ø 20 cm**
 Struttura in acciaio alta **73.5 cm** per tavolo fisso
 Colore standard
 Top tavolo escluso

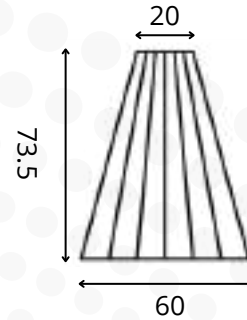

Base **Ø 60 cm** with minimum opening **Ø 20 cm**
 Steel structure **73.5 cm** high for fixed table
 Standard color
 Table top not included

Forme e dimensioni top possibili



min 120 / max 130 cm

Art. 00-25-02**€ 1.170,00**

Due basi **Ø 60 cm** con minima apertura **Ø 20 cm**
 Struttura in acciaio alta **73.5 cm** per tavolo fisso
 Colore standard
 Top tavolo escluso

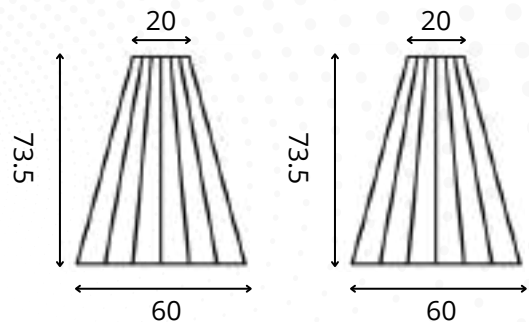

Two bases **Ø 60 cm** with minimum opening **Ø 20 cm**
 Steel structure **73.5 cm** high for fixed table
 Standard color
 Table top not included

Forme e dimensioni top possibili



min 200 / max 240 cm

FINITURE TOP TAVOLO PAG. 133 - PREZZI TOP TAVOLO PAG. 153
 TABLE TOP FINISHES PAG. 133 - TABLE TOP PRICES PAG. 153



DAISY



IRIS

Art. 00-30

La caratteristica di questo tavolo è la geometria delle linee, evidenziata dalla sua base conica in acciaio che consente di sperimentare con la forma del piano, per creare un insieme di forme e dimensioni affascinanti.

The characteristic feature of this table is the geometry of its lines, highlighted by its conical steel base that allows you to experiment with the shape of the top, to create a set of fascinating shapes and sizes.

COLORE STRUTTURA STANDARD - STANDARD STRUCTURE COLOR



Bronzo
Metallizzato



Rame
Metallizzato



Alluminio
Goffrato



Avorio
Opaco



Beige
Grigio

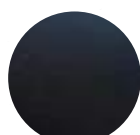

Nero
Bucciato



Bianco
Bucciato

Art. 00-30-01**€ 1.853,00**

Base \varnothing 81.7 cm con minima apertura \varnothing 30 cm
 Struttura in acciaio alta 72.5 cm per tavolo fisso
 Colore standard
 Top tavolo escluso

Base \varnothing 81.7 cm with minimum opening \varnothing 30 cm
 Steel structure 72.5 cm high for fixed table
 Standard color
 Table top not included

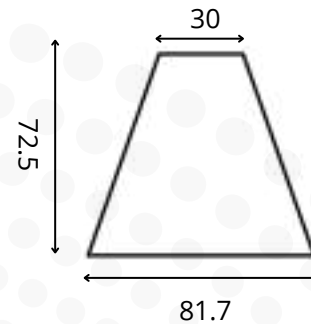
Forme e dimensioni top possibili

min 120 / max 130 cm

Art. 00-30-02**€ 3.706,00**

Due basi \varnothing 81.7 cm con minima apertura \varnothing 30 cm
 Struttura in acciaio alta 72.5 cm per tavolo fisso
 Colore standard
 Top tavolo escluso

Two bases \varnothing 81.7 cm with minimum opening \varnothing 30 cm
 Steel structure 72.5 cm high for fixed table
 Standard color
 Table top not included

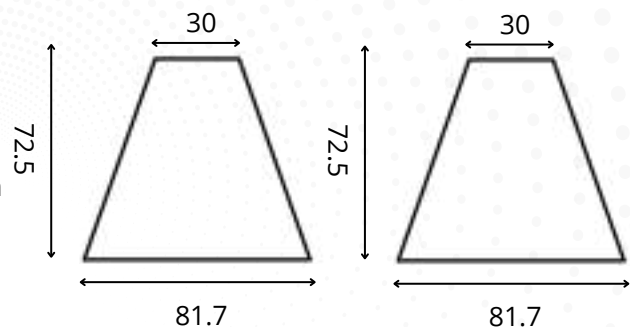
Forme e dimensioni top possibili

min 200 / max 240 cm

FINITURE TOP TAVOLO PAG. 133 - PREZZI TOP TAVOLO PAG. 153
 TABLE TOP FINISHES PAG. 133 - TABLE TOP PRICES PAG. 153



IRIS



CLOVER

Art. 00-35

Maestoso ma fluido, questo tavolo diventa il centro della stanza grazie alla sofisticata combinazione dei cilindri in acciaio che gli conferiscono stabilità ed armonia.

Majestic yet fluid, this table becomes the center of the room thanks to the sophisticated combination of steel cylinders that give it stability and harmony.

COLORE STRUTTURA STANDARD - STANDARD STRUCTURE COLOR



Bronzo
Metallizzato



Rame
Metallizzato



Alluminio
Goffrato



Avorio
Opaco



Beige
Grigio

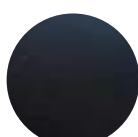

Nero
Bucciato



Bianco
Bucciato

Art. 00-35-01**€ 977,00**

Base **Ø 55 cm** - 3 cilindri Ø 25 cm
 Struttura in acciaio alta **72 cm** per tavolo fisso
 Colore standard
 Top tavolo escluso

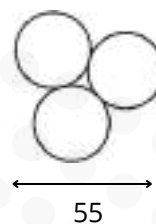

Base **Ø 55 cm** - 3 cylinders Ø 25 cm
 Steel structure **72 cm** high for fixed table
 Standard color
 Table top not included

Forme e dimensioni top possibili**Art. 00-35-02****€ 1.325,00**

Base **Ø 60 cm** - 4 cilindri Ø 25 cm
 Struttura in acciaio alta **72 cm** per tavolo fisso
 Colore standard
 Top tavolo escluso

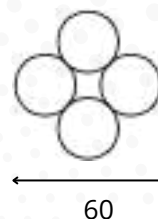

Base **Ø 60 cm** - 4 cylinders Ø 25 cm
 Steel structure **72 cm** high for fixed table
 Standard color
 Table top not included

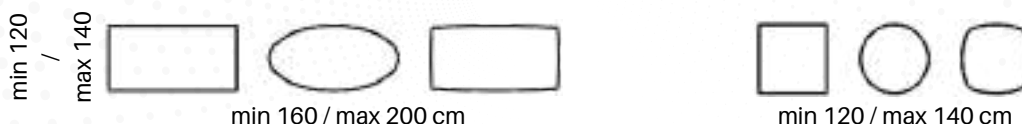
Forme e dimensioni top possibili**Art. 00-35-03****€ 3.535,00**

Base **Ø 100 cm** - 6 cilindri Ø 25 cm + 1 cilindro Ø 50 cm
 Struttura in acciaio alta **72 cm** per tavolo fisso
 Colore standard
 Top tavolo escluso

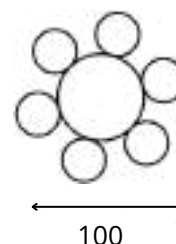

Base **Ø 100 cm** - 6 cylinders Ø 25 cm + 1 cylinder Ø 50 cm
 Steel structure **72 cm** high for fixed table
 Standard color
 Table top not included

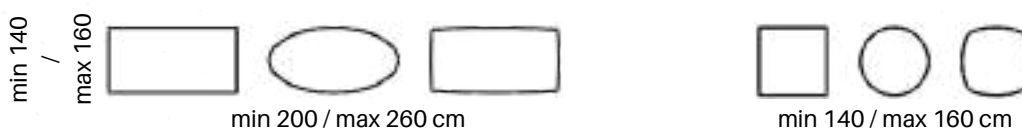
Forme e dimensioni top possibili

FINITURE TOP TAVOLO PAG. 133 - PREZZI TOP TAVOLO PAG. 153
 TABLE TOP FINISHES PAG. 133 - TABLE TOP PRICES PAG. 153



CLOVER



CLOVER WOOD

Art. 00-36

I cilindri in ferro, rivestiti da listelli in legno naturale o verniciato, sono la base di questo tavolo imponente, che unisce elementi moderni e rustici in modo sorprendente.

The iron cylinders, covered with natural or painted wooden strips, are the base of this imposing table, which combines modern and rustic elements in a surprising way.

COLORE STRUTTURA STANDARD - STANDARD STRUCTURE COLOR



naturale



nero



noce chiaro



noce scuro



rovere

Base Ø 102.5 cm - 6 cilindri Ø 25 cm + 1 cilindro Ø 50 cm
Struttura in acciaio alta 72 cm per tavolo fisso
Colore standard
Top tavolo escluso



102.5

Base Ø 102.5 cm - 6 cylinders Ø 25 + 1 cylinder Ø 50 cm
Steel structure 72 cm high for fixed table
Standard color
Table top not included

Forme e dimensioni top possibili

min 140
/
max 160



min 200 / max 260 cm



min 140 / max 160 cm



Nucleo



CLOVER WOOD



STEM

Art. 00-37

Una singola base in ferro e legno cattura lo sguardo su questo tavolo senza tempo che, arricchito dal suo piano, conferisce uno stile shabby chic a qualsiasi spazio.

A single iron and wood base captures the eye on this timeless table which, enriched by its top, gives a shabby chic style to any space.

COLORE STRUTTURA STANDARD - STANDARD STRUCTURE COLOR



naturale

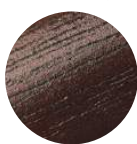

nero



noce chiaro



noce scuro



rovere

Art. 00-37-01**€ 1.713,00****Base Ø 53 cm**

Zoccolo in acciaio h.5 cm finitura 24k o ral Standard
 Struttura in acciaio alta **72 cm** rivestita con listelli di legno per tavolo fisso
 Colore standard
 Top tavolo escluso

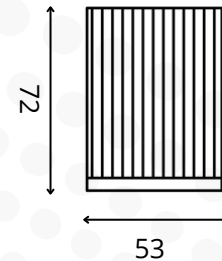
**Base Ø 53 cm**

Steel plinth h.5 cm 24k or RAL Standard finish
 Steel structure **72 cm** high covered with wooden strips for fixed table
 Standard color
 Table top not included

Forme e dimensioni top possibili**Art. 00-37-02****€ 3.426,00****Due basi Ø 53 cm**

Zoccolo in acciaio h.5 cm finitura 24k o ral Standard
 Struttura in acciaio alta **72 cm** rivestita con listelli di legno
 Per tavolo fisso
 Colore standard
 Top tavolo escluso

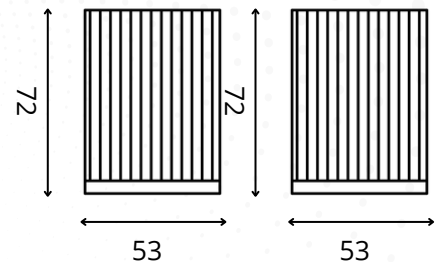
**Two bases Ø 53 cm**

Steel plinth h.5 cm 24k or RAL Standard finish
 Steel structure **72 cm** high covered with wooden strips
 For fixed table
 Standard color
 Table top not included

Forme e dimensioni top possibili

FINITURE TOP TAVOLO PAG. 133 - PREZZI TOP TAVOLO PAG. 153
 TABLE TOP FINISHES PAG. 133 - TABLE TOP PRICES PAG. 153



STEM



ROOT

Art. 00-38

Questo tavolo imponente e magnifico conferisce al tuo ambiente uno stile ed eleganza unici, grazie alla sua struttura in acciaio rivestita da listelli in legno fissati uno per uno che esalta la perfezione artigiana del made in Italy.

This imposing and magnificent table gives your environment a unique style and elegance, thanks to its steel structure covered with wooden slats fixed one by one that enhances the artisan perfection of Made in Italy.

COLORE STRUTTURA STANDARD - STANDARD STRUCTURE COLOR



naturale

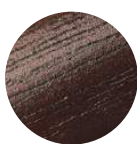

nero



noce chiaro



noce scuro



rovere

Art. 00-38-01**€ 3.033,00**Base **101.5x45.5 cm**Struttura in acciaio alta **73 cm** rivestita con listelli di legno

Per tavolo fisso

Colore standard

Top tavolo escluso

Base **101.5x45.5 cm**Steel structure **73 cm** high covered with wooden slats

For fixed table

Standard color

Table top not included

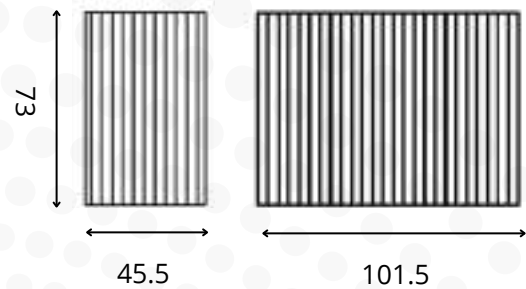
Forme e dimensioni top possibili**Art. 00-38-02****€ 4.148,00**Base **151.5x45.5 cm**Struttura in acciaio alta **73 cm** rivestita con listelli di legno

Per tavolo fisso

Colore standard

Top tavolo escluso

Base **151.5x45.5 cm**Steel structure **73 cm** high covered with wooden slats

For fixed table

Standard color

Table top not included

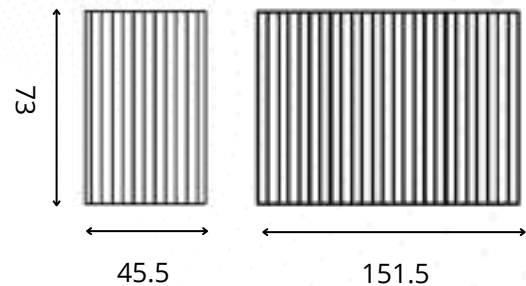
Forme e dimensioni top possibili

FINITURE TOP TAVOLO PAG. 133 - PREZZI TOP TAVOLO PAG. 153
 TABLE TOP FINISHES PAG. 133 - TABLE TOP PRICES PAG. 153



ROOT



SQUARE

Art. 00-40

Questo tavolo solido e squadrato rappresenta una perfetta combinazione di robustezza, leggerezza ed eleganza. La sua struttura geometrica e lineare offre una sensazione di stabilità e resistenza, adattandosi facilmente a diversi stili di arredamento.

This solid and square table represents a perfect combination of strength, lightness and elegance. Its geometric and linear structure offers a feeling of stability and resistance, it easily adapts to different styles of furniture.

COLORE STRUTTURA STANDARD - STANDARD STRUCTURE COLOR



Bronzo
Metallizzato



Rame
Metallizzato



Alluminio
Goffrato



Avorio
Opaco



Beige
Grigio

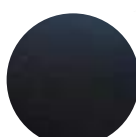

Nero
Bucciato



Bianco
Bucciato

Art. 00-40-01**€ 1.539,00**

Base **160X70 cm** - piede 10x2 cm
 Struttura in acciaio alta **72 cm** per tavolo fisso
 Colore standard
 Top tavolo escluso

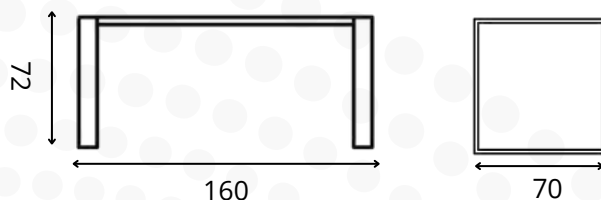

Base **160X70 cm** - foot 10x2 cm
 Steel structure **72 cm** high for fixed table
 Standard color
 Table top not included

Forme e dimensioni top possibili**Art. 00-40-02****€ 1.605,00**

Base **180X90 cm** - piede 10x2 cm
 Struttura in acciaio alta **72 cm** per tavolo fisso
 Colore standard
 Top tavolo escluso

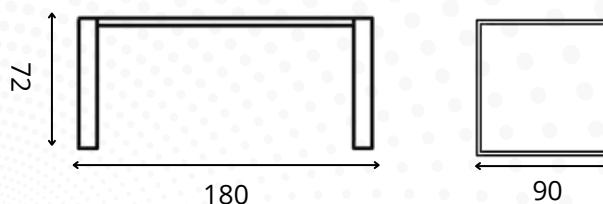

Base **180X90 cm** - foot 10x2 cm
 Steel structure **72 cm** high for fixed table
 Standard color
 Table top not included

Forme e dimensioni top possibili**Art. 00-40-03****€ 1.671,00**

Base **200X90 cm** - piede 10x2 cm
 Struttura in acciaio alta **72 cm** per tavolo fisso
 Colore standard
 Top tavolo escluso

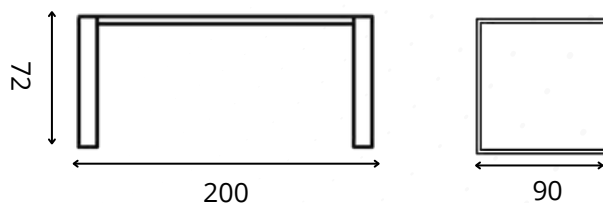

Base **200X90 cm** - foot 10x2 cm
 Steel structure **72 cm** high for fixed table
 Standard color
 Table top not included

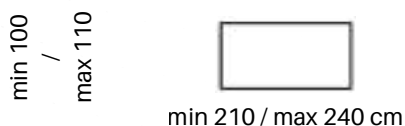
Forme e dimensioni top possibili

FINITURE TOP TAVOLO PAG. 133 - PREZZI TOP TAVOLO PAG. 153
 TABLE TOP FINISHES PAG. 133 - TABLE TOP PRICES PAG. 153



SQUARE



Nucleo

Tavoli Allungabili

Extendable Tables

2025



SUMMER

Art. 40-00

Le quattro gambe che si uniscono al centro e poi si allargano rappresentano l'essenza estetica di questo tavolo. Grazie al suo meccanismo rotante che lo rende allungabile, si adatta perfettamente a qualsiasi arredamento, sia interno che esterno, classico o moderno. Puoi scegliere di abbinarlo a uno dei numerosi colori dei piani in gres che produciamo. Le sue dimensioni fisse e allungabili sono perfette per soddisfare le esigenze degli ambienti familiari.

The four legs that meet in the center and then spread out represent the aesthetic essence of this table. Thanks to its rotating mechanism that allows it to be extended, it fits perfectly with any decor, both indoors and outdoors, classic or modern. You can choose to match it with one of the many colors of the stoneware tops we produce. Its fixed and extendable dimensions are perfect for meeting the needs of family spaces.

- Telaio in acciaio verniciato a polvere
- Finitura: verniciato nero
- Movimento sincronizzato rotante
- Dimensioni tavolo chiuso: 120x90xh.75 cm
- Dimensioni tavolo aperto: 180x90xh.75 cm
- Top tavolo escluso
- Top tavolo realizzabile sono in ceramica 1,2 cm
- Powder-coated steel frame
- Finish: Black painted
- Rotating synchronized movement
- Closed table dimensions: 120x90xh.75 cm
- Open table dimensions: 180x90xh.75 cm
- Table top not included
- The table top can be made of 1,2 cm ceramic





FALCON

Art. 50-00

Agendo agevolmente sulla leva si attiva il meccanismo rotante utile ad allungare il tavolo , mantenendo fisse al centro le quattro gambe inclinate e separate tra loro che offrono un design semplice ed efficace

Gambe colore nero opaco per abbinarlo a tutte le tipologie di piani in gres di nostra produzione
Due alternative di misure fisse ed a allungabili soddisfano il ritrovo anche di grandi compagnie

Easily operating the lever activates the rotating mechanism that extends the table, keeping the four tilted and separated legs fixed in the center, offering a simple and effective design.

Matte black legs to match all types of stoneware tops we produce.

Two alternatives, fixed and extendable, satisfy the needs of even large gatherings.

Art. 50-00-01**€ 1.441,00**

- Telaio in acciaio verniciato a polvere
- Finitura: verniciato nero
- Movimento sincronizzato rotante
- Dimensioni tavolo chiuso: 120x90xh.75 cm
- Dimensioni tavolo aperto: 180x90xh.75 cm
- Top tavolo escluso
- Top tavolo realizzabile sono in ceramica 1,2 cm
- Powder-coated steel frame
- Finish: Black painted
- Rotating synchronized movement
- Closed table dimensions: 120x90xh.75 cm
- Open table dimensions: 180x90xh.75 cm
- Table top not included
- The table top can be made of 1,2 cm ceramic

Art. 50-00-02**€ 1.651,00**

- Telaio in acciaio verniciato a polvere
- Finitura: verniciato nero
- Movimento sincronizzato rotante
- Dimensioni tavolo chiuso: 160x90xh.75 cm
- Dimensioni tavolo aperto: 240x90xh.75 cm
- Top tavolo escluso
- Top tavolo realizzabile sono in ceramica 1,2 cm
- Powder-coated steel frame
- Finish: Black painted
- Rotating synchronized movement
- Closed table dimensions: 160x90xh.75 cm
- Open table dimensions: 240x90xh.75 cm
- Table top not included
- The table top can be made of 1,2 cm ceramic



FINITURE TOP TAVOLO PAG. 140-142 - PREZZI TOP TAVOLO PAG. 153
TABLE TOP FINISHES PAG. 140-142 - TABLE TOP PRICES PAG. 153



SPRING

Art. 51-00

Quattro gambe intrecciate conferiscono a questo tavolo un aspetto simile a molti altri, ma un'attenta osservazione rivela che la loro diversa larghezza e inclinazione lo rendono davvero unico.

Il sistema di allunghe esterne e indipendenti consente di trasformare il piano in tre misure diverse: da fisso per spazi medio-piccoli fino all'allungo massimo per ambienti più ampi.

Four intertwined legs give this table a look similar to many others, but upon closer inspection, their varying widths and angles make it truly unique.

The independent, external extension system allows the tabletop to be extended to three different sizes: from fixed for small to medium-sized spaces to fully extendable for larger spaces.

- Telaio in acciaio verniciato a polvere
- Finitura: verniciato nero
- Due allunghe laterali
- Dimensioni tavolo chiuso: 160x90xh.75 cm
- Dimensioni tavolo aperto: 240x90xh.75 cm
- Top tavolo escluso
- Top tavolo realizzabile sono in ceramica 1,2 cm
- Powder-coated steel frame
- Finish: Black painted
- Two side extensions
- Closed table dimensions: 160x90xh.75 cm
- Open table dimensions: 240x90xh.75 cm
- Table top not included
- The table top can be made of 1,2 cm ceramic





EAGLE

Art. 52-00

In questo tavolo si racchiude la bellezza della semplicità e l'efficienza del design, con il nostro piano in gres che sembra fluttuare sopra il telaio.

Le quattro gambe, di cui solo due si allungano, creano un affascinante gioco di spazi vuoti e solidi. Sia la misura fissa che quella allungata si adattano perfettamente a qualsiasi ambiente di medie dimensioni.

This table embodies the beauty of simplicity and efficient design, with our stoneware top seemingly floating above the frame.

The four legs, only two of which extend, create a fascinating interplay of empty and solid spaces.

Both the fixed and extended versions are perfect for any medium-sized space.

- Telaio in acciaio verniciato a polvere
- Finitura: verniciato nero
- Meccanismo scorrevole
- Dimensioni tavolo chiuso: 140x90xh.75 cm
- Dimensioni tavolo aperto: 200x90xh.75 cm
- Top tavolo escluso
- Top tavolo realizzabile sono in ceramica 1,2 cm
- Powder-coated steel frame
- Finish: Black painted
- Sliding mechanism
- Closed table dimensions: 140x90xh.75 cm
- Open table dimensions: 200x90xh.75 cm
- Table top not included
- The table top can be made of 1,2 cm ceramic







Consolle

Consolle

2025



MADRID

Art. 100-01

La madia MADRID, con le sue linee squadrate e geometriche, incarna l'essenzialità e la semplicità. La vasta gamma di finiture in legno o laccato o ceramica, arricchita da eleganti ripiani, ci consente di realizzare abbinamenti sia eccentrici che classici, adattandosi perfettamente alla nostra visione di ambiente.

The MADRID sideboard, with its square, geometric lines, embodies essentiality and simplicity. The wide range of finishes—wood, lacquer, or ceramic—enhanced with elegant shelves allows for both eccentric and classic combinations, perfectly adapting to your space's vision.



MADRID

FINITURE IN LEGNO MASSELLO MASSELLO WOOD FINISHES

Per basi mobili For furniture bases



Castagno Naturale Levigato



Castagno Levigato Saponato



Castagno Ossidato Grigio Levigato



Castagno Moro Levigato



Castagno Vecchio non Levigato

COLORI LACCATI LUCIDI - OPACHI COLOUR MATT LACQUARED

Per basi mobili For mobile bases

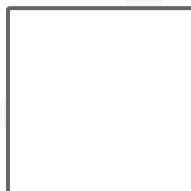

Bianco

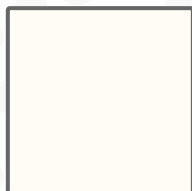

Panna

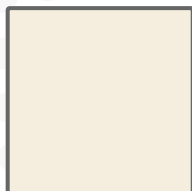

Crema

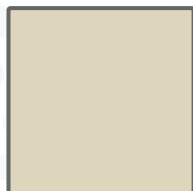

Caffè Latte



Beige Cipria



Giallo Canarino



Giallo Senape



Beige Perlato



Canapa



Marrone



Grigio Fumo

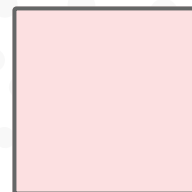

Rosa Chiaro

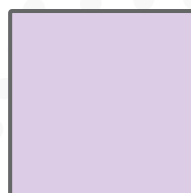

Lilla

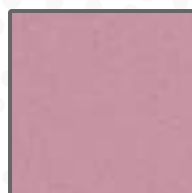

Fucsia Perlato

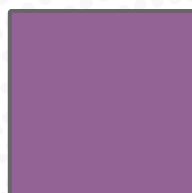

Prugna



Fucsia



Lavanda



Melanzana



Arancio



Rosso Rubino

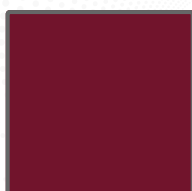

Rosso Porpora

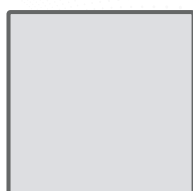

Grigio Luce



Grigio Medio

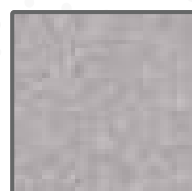

Grigio Metal



Grigio Antracite

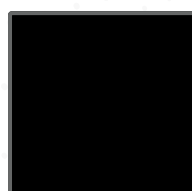

Nero



Azzurro Limpido

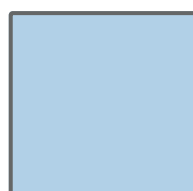

Azzurro Cielo



Blu Colomba



Blu Oceano



Blu Notte



Verde Cristallo



Verde Turchese



Verde Salvia

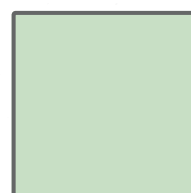

Verde Acqua



Verde Mela

FINITURE ANTE IN GRES 6 MM

GRES 6 MM DOOR FINISHES

Per basi mobili For furniture bases

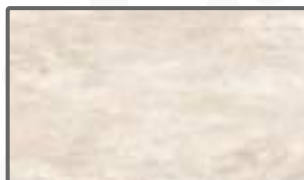

Ardesia Bianco



Ardesia Ecrú'



Ardesia Grigia



Ardesia Nera



Calacatta Oro O.



Corten



Grafite



Limestone Ash



Limestone Deep

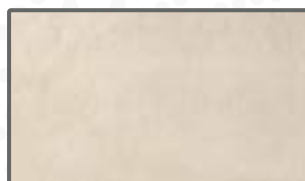

Limestone Moon



Spatolato Amber

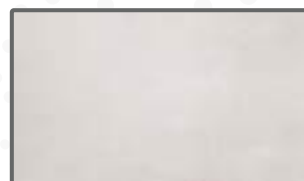

Spatolato Ivory

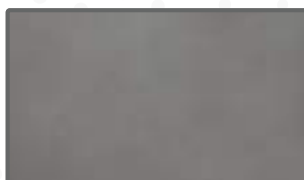

Spatolato Plumb

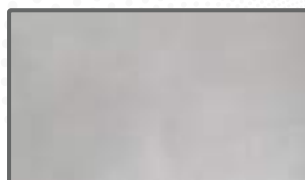

Spatolato Silver



Statuario



Travertino Gold



Verde Alpi



Azzurro



Calacatta Bianco



Calacatta Oro L.



Emperador (C6)



Gaudi (C6)



Nero Marquinia



Nero Portoro



Onice Noisette



Port Laurent



Travertino

BASI PROFONDITA' 50 CM - sistema di apertura PUSH-PULL
BASES DEPTH 46 CM - opening system PUSH-PULL

Base 2 cassetti H.50 cm
 base 2 drawers H.50 cm



LARGHEZZA (CM) WIDHT (CM)	CODICE CODE	LACCATO OPACO MATT LACQUERED	LACCATO LUCIDO GLOSSY LACQUERED	LEGNO CASTAGNO CHESTNUT WOOD	GRES GRES
25	LGLF10	€ 881,00	€ 943,00	€ 1.061,00	€ 1.251,00
35	LGLF11	€ 927,00	€ 993,00	€ 1.117,00	€ 1.317,00
50	LGLF12	€ 975,00	€ 1.045,00	€ 1.176,00	€ 1.387,00
70	LGLF13	€ 1.027,00	€ 1.101,00	€ 1.238,00	€ 1.460,00
85	LGLF14	€ 1.102,00	€ 1.190,00	€ 1.358,00	€ 1.624,00
100	LGLF15	€ 1.165,00	€ 1.269,00	€ 1.467,00	€ 1.780,00
120	LGLF16	€ 1.256,00	€ 1.379,00	€ 1.617,00	€ 1.993,00

finiture riferite solo alla parte frontale delle basi.
finishes referring only to the front part of the bases.

Base contenitore 1 anta H.50 cm
 1 door container base H.50 cm



LARGHEZZA (CM) WIDHT (CM)	CODICE CODE	LACCATO OPACO MATT LACQUERED	LACCATO LUCIDO GLOSSY LACQUERED	LEGNO CASTAGNO CHESTNUT WOOD	GRES GRES
25	LGLF30	€ 532,00	€ 625,00	€ 707,00	€ 790,00
35	LGLF31	€ 561,00	€ 657,00	€ 745,00	€ 831,00

finiture riferite solo alla parte frontale delle basi.
finishes referring only to the front part of the bases.

Base contenitore 2 ante H.50 cm
 2 doors container base H.50 cm



LARGHEZZA (CM) WIDHT (CM)	CODICE CODE	LACCATO OPACO MATT LACQUERED	LACCATO LUCIDO GLOSSY LACQUERED	LEGNO CASTAGNO CHESTNUT WOOD	GRES GRES
50	LGLF40	€ 591,00	€ 691,00	€ 784,00	€ 874,00
70	LGLF41	€ 622,00	€ 727,00	€ 825,00	€ 920,00

finiture riferite solo alla parte frontale delle basi.
finishes referring only to the front part of the bases.

FIANCHI DI FINITURA P.50
FINISHING SIDES P.50

Fianco di finitura H.50 cm
 Finishing side H.50 cm



LARGHEZZA (CM) WIDHT (CM)	CODICE CODE	LACCATO OPACO MATT LACQUERED	LACCATO LUCIDO GLOSSY LACQUERED	LEGNO CASTAGNO CHESTNUT WOOD	GRES GRES
50	LGLFFI	€ 218,00	€ 259,00	€ 284,00	€ 383,00

ATTENZIONE: per la composizione del mobile è sempre necessario scegliere e aggiungere i due fianchi di finitura
ATTENTION: to compose the furniture it is always necessary to choose and add the two finishing sides

PIEDI DI METALLO PER BASI
METAL FEET FOR BASES

Piedi di metallo H.12 cm
 Metal feet H.12 cm



CODICE CODE	LEGNO MELAMINICO MELAMINIC WOOD
LGLFPI	€ 266,00

MANIGLIE HANDLESS

Tutti i prezzi della basi sono riferiti con sistema di apertura PUSH-PULL per ante/cassetti.

Si puo' inserire il sistema di apertura a maniglia scegliendo tra i modelli elencati.

ATTENZIONE:
Le maniglie non possono essere applicate sulle ante /cassetti con il rivestimento frontale in gres ad esclusione della maniglia **SEGNO** che va avvitata sul lato interno.

All base unit prices include a PUSH-PULL opening system for doors/drawers.

A handle opening system can be installed by choosing from the models listed.

PLEASE NOTE:
Handles cannot be applied to doors/drawers with a stoneware front, with the exception of the **SEGNO** handle, which must be screwed onto the inside.

LINE



Maniglia in alluminio
verniciato a polvere
Nero Opaco

Aluminum handle
Powder-coated
Matte Black

LUNGHEZZA(CM) LENGTH(CM)	CODICE CODE	PREZZO PRICE
18	LGLFM50	€ 12,00
30	LGLFM51	€ 17,00
45	LGLFM52	€ 25,00
60	LGLFM53	€ 33,00
90	LGLFM54	€ 46,00
120	LGLFM55	€ 55,00



Schema posizionamento maniglie - hanle positioning diagram



L.BASE L.BASE	L.MANIGLIA L.HANDLESS
25	20
35	20/30
50	30/45
70	30/45/60
85	45/60
100	45/60/90
120	60/90/120



L.BASE L.BASE	L.MANIGLIA L.HANDLESS
25	20
35	20/30

SEGNO



Maniglia in alluminio
verniciato a polvere
Nero Opaco

Aluminum handle
Powder-coated
Matte Black

LUNGHEZZA(CM) LENGTH(CM)	CODICE CODE	PREZZO PRICE
18	LGLFM70	€ 12,00
28	LGLFM71	€ 16,00
33	LGLFM72	€ 17,00
38	LGLFM73	€ 19,00
48	LGLFM74	€ 26,00
68	LGLFM75	€ 32,00



Schema posizionamento maniglie - hanle positioning diagram



L.BASE L.BASE	L.MANIGLIA L.HANDLESS
25	18
35	18/28
50	28/33
70	38/48
85	38/48/68
100	48/68
120	48/68



L.BASE L.BASE	L.MANIGLIA L.HANDLESS
25	20
35	20/30

RULE



Maniglia in metallo pieno
sp. 5mm verniciata a
polvere Nero Opaco

Solid metal handle
5mm thick, powder-coated
Matte Black

LUNGHEZZA (CM) LENGTH (CM)	CODICE CODE	PREZZO PRICE
17	LGLFM80	€ 39,00
25	LGLFM81	€ 67,00



Schema posizionamento maniglie - handle positioning diagram

L.BASE L.BASE	L.MANIGLIA L.HANDLESS
25	25/17
35	25/17
50	25/17
70	25/17
85	25/17
100	25/17
120	25/17

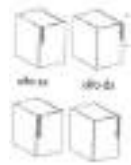

L.BASE L.BASE	L.MANIGLIA L.HANDLESS
25	25/17
35	25/17

LACE



Maniglia in metallo
Nero Opaco e cinturino
in pelle colore
testa di moro.

Matte black metal handle
and dark brown leather
strap.

LARGHEZZA (CM) WIDHT (CM)	CODICE CODE	PREZZO PRICE
18	LGLFM90	€ 53,00

Schema posizionamento maniglie - handle positioning diagram

L.BASE L.BASE	L.MANIGLIA L.HANDLESS
25	14
35	14
50	14
70	14
85	14
100	14
120	14



L.BASE L.BASE	L.MANIGLIA L.HANDLESS
25	14
35	14



PARIGI

Art. 100-02

La madia PARIGI rappresenta l'incontro perfetto tra design e praticità, l'ideale equilibrio tra estetica e funzionalità. Con una base ovale in metallo dalle linee morbide e minimaliste, è impreziosita da un piano in marmo o gres, capace di arricchire e valorizzare qualsiasi ambiente.

Giocando con colori e materiali, è possibile creare una combinazione che si adatta a ogni stile di arredamento e a ogni personalità.

The PARIGI sideboard represents the perfect blend of design and practicality, the ideal balance between aesthetics and functionality. Featuring an oval metal base with soft, minimalist lines, it is embellished with a marble or stoneware top, capable of enriching and enhancing any space.

By playing with colors and materials, you can create a combination that adapts to any furnishing style and personality.



PARIGI

FINITURE ACCIAIO STANDARD STANDARD STEEL FINISHES

Per basi mobili For furniture bases



Bronzo Metallizzato



Rame Metallizzato



Alluminio Goffrato



Avorio Opaco



Beige Grigio



Nero Bucciato

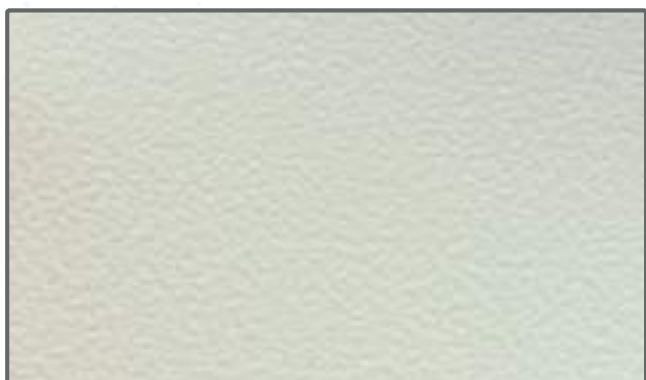

Bianco Bucciato

**MADIA ALTEZZA 73 CM
SIDEBOARD HEIGHT 73 CM**

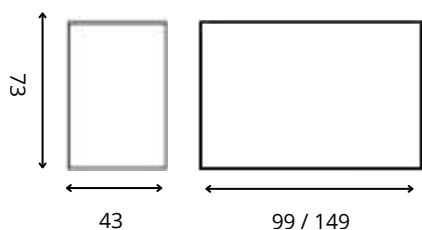

Struttura in acciaio - Colore standard
Top madia esclusa

Steel structure - Standard color
sideboard top not included

MISURE (CM) MISURES (CM)	CODICE CODE	PREZZO PRICE
99X43	VEIK100	€ 1.121,00
149X43	VEIK101	€ 1.655,00

Forma e dimensione top

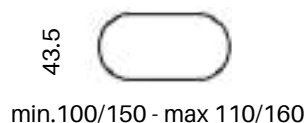

**MADIA ALTEZZA 110 CM
SIDEBOARD HEIGHT 110 CM**

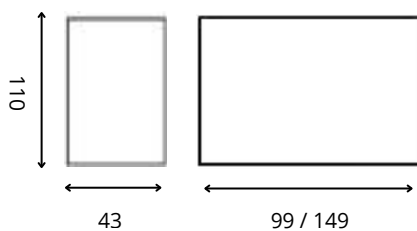

Struttura in acciaio - Colore standard
Top madia esclusa

Steel structure - Standard color
sideboard top not included

MISURE (CM) MISURES (CM)	CODICE CODE	PREZZO PRICE
99x43	VEIK150	€ 2.256,00
149X43	VEIK151	€ 3.311,00

Forma e dimensione top

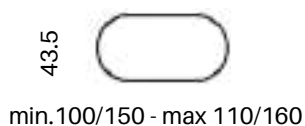



VIENNA

Art. 100-03

I listelli in legno con diverse finiture conferiscono alla madia VIENNA un calore di eleganza senza tempo, arricchita da ripiani in marmo o gres. Versatile e raffinata, rappresenta un complemento d'arredo ideale sia per ambienti moderni che per quelli dal sapore retrò.

The wooden slats in various finishes give the VIENNA sideboard a warm, timeless elegance, enhanced by marble or stoneware shelves. Versatile and refined, it's an ideal furnishing accessory for both modern and retro-inspired spaces.



VIENNA

FINITURE IN LEGNO MASSELLO

MASSELLO WOOD FINISHES

Per basi mobili For furniture bases

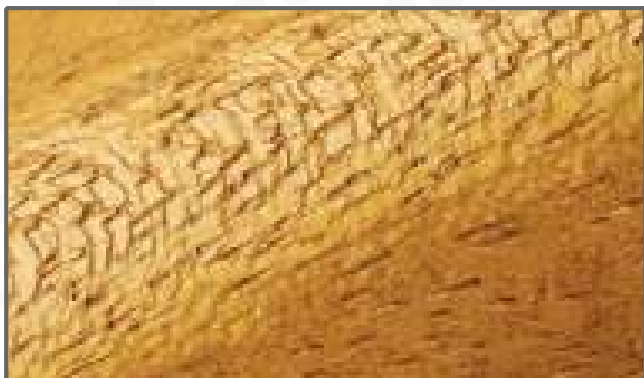

Naturale



Nero

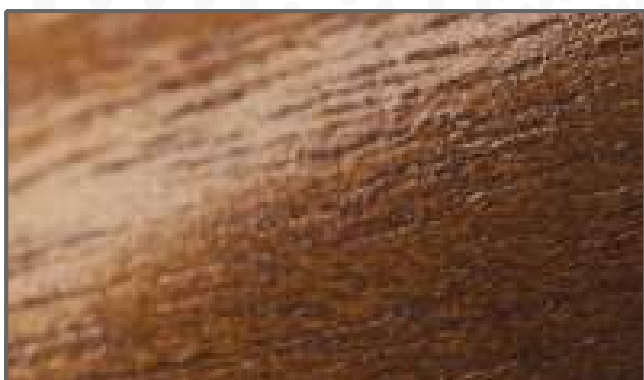

Noce Chiaro



Noce Scuro



Rovere

**MADIA ALTEZZA 73 CM
SIDEBOARD HEIGHT 73 CM**

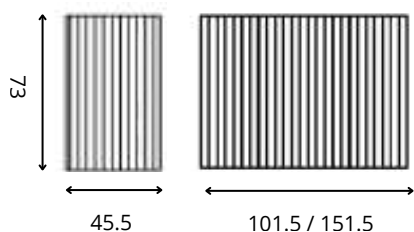

Struttura in acciaio rivestita di listelli
in legno - Colore standard
Top madia esclusa

Steel structure covered with
wooden slats - Standard color
sideboard top not included

MISURE (CM) MISURES (CM)	CODICE CODE	PREZZO PRICE
101.5x45.5	VEIKW50	€ 2.947,00
151.5x45.5	VEIKW51	€ 4.070,00

Forma e dimensione top

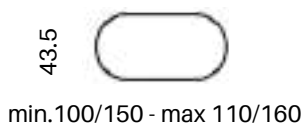

**MADIA ALTEZZA 110 CM
SIDEBOARD HEIGHT 110 CM**

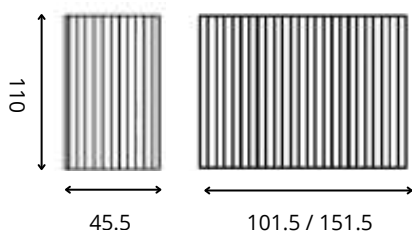

Struttura in acciaio rivestita di listelli
in legno - Colore standard
Top madia esclusa

Steel structure covered with
wooden slats - Standard color
sideboard top not included

MISURE (CM) MISURES (CM)	CODICE CODE	PREZZO PRICE
101.5x45.5	VEIKW70	€ 5.894,00
151.5x45.5	VEIKW71	€ 8.152,00

Forma e dimensione top





LONDRA

Art. 100-04

La madia LONDRA, elegante e funzionale, con i suoi listelli in legno e mensole, rappresenta un perfetto connubio tra raffinatezza e praticità. La sua versatilità nelle tonalità delle finiture in legno e nei materiali abbinabili la rende ideale per qualsiasi ambiente della casa.

The elegant and functional LONDRA sideboard, with its wooden slats and shelves, represents the perfect combination of refinement and practicality. Its versatility in wood finishes and matching materials makes it ideal for any room in the home.



LONDRA

FINITURE IN LEGNO MASSELLO

MASSELLO WOOD FINISHES

Per basi mobili For furniture bases

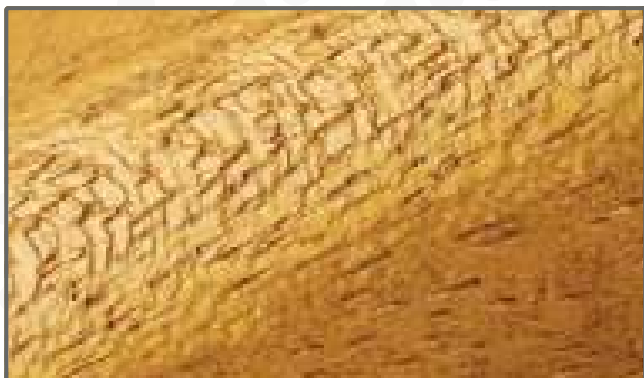

Naturale



Nero

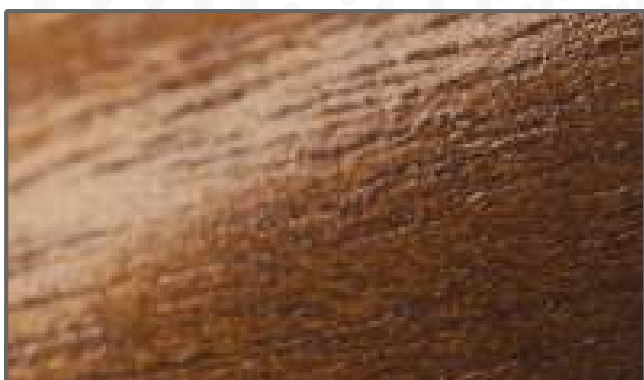

Noce Chiaro



Noce Scuro



Rovere

**MADIA ALTEZZA 110 CM
SIDEBOARD HEIGHT 110
CM**

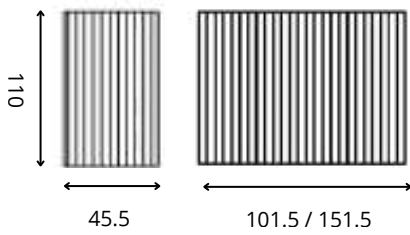

Struttura in acciaio rivestita di listelli
in legno - con mensole
Colore standard
Top madia esclusa

Steel structure covered with
wooden slats - with shelves
Standard color
sideboard top not included

MISURE (CM) MISURES (CM)	CODICE CODE	PREZZO PRICE
101.5x45.5	VEIKB200	€ 4.276,00
151.5x45.5	VEIKB201	€ 8.059,00

Forma e dimensione top

43.5



min.100/150 - max 110/160



BERLINO

Art. 100-05

La consolle BERLINO, caratterizzata da un design semplice ed elegante, rappresenta un perfetto connubio tra raffinatezza e minimalismo. La base in ferro, personalizzabile in diverse tonalità, sostiene un piano in marmo, quarzo o ceramica che ne valorizza lo stile.

The BERLINO console table, featuring a simple and elegant design, represents the perfect blend of sophistication and minimalism. The iron base, customizable in a variety of shades, supports a marble, quartz, or ceramic top that enhances its style.



BERLINO

FINITURE ACCIAIO STANDARD STANDARD STEEL FINISHES

Per basi mobili For furniture bases



Bronzo Metallizzato



Rame Metallizzato



Alluminio Goffrato



Avorio Opaco



Beige Grigio



Nero Bucciato

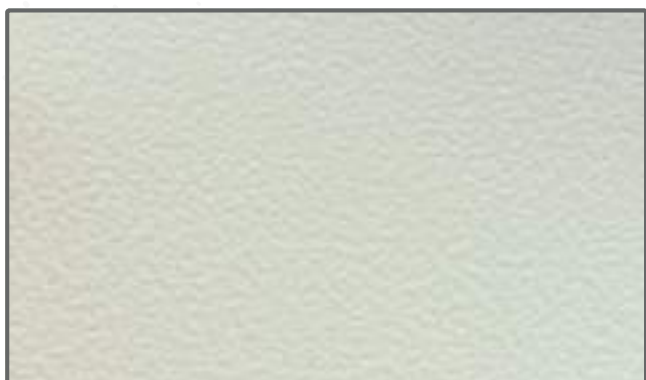

Bianco Bucciato

**MADIA ALTEZZA 87 CM
SIDEBOARD HEIGHT 87
CM**

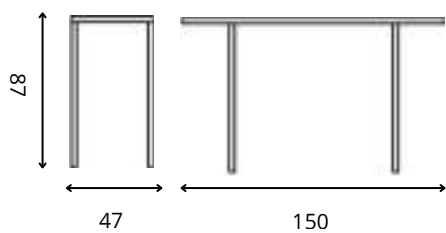

Struttura in acciaio
Colore standard
Top madia esclusa

Steel structure
Standard color
sideboard top not included

MISURE (CM) MISURES (CM)	CODICE CODE	PREZZO PRICE
150x47	LPBAN70	€ 2.876,00

Forma e dimensione top

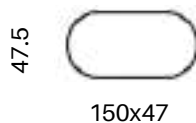

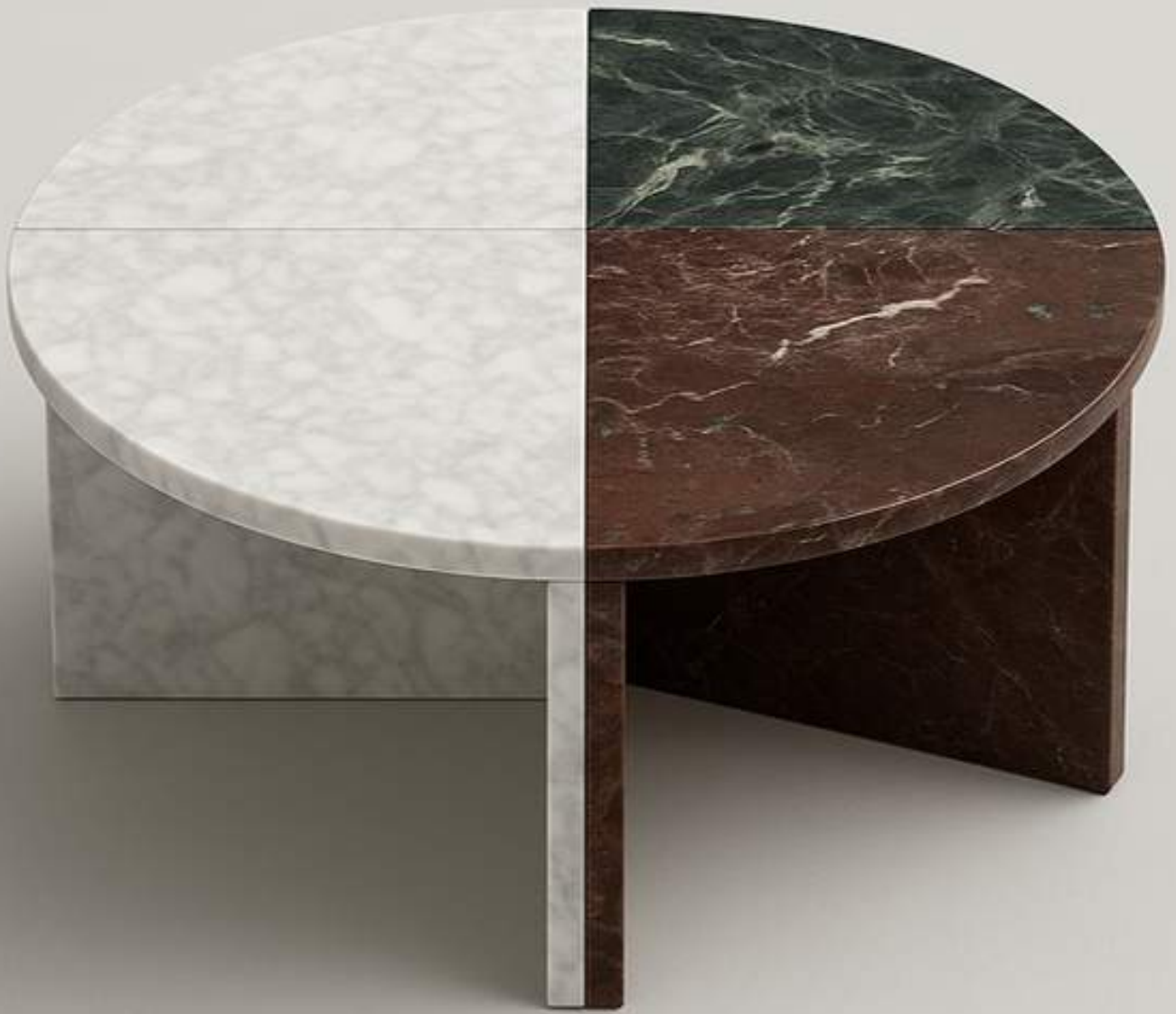



Tavolini

Coffee Tables

2025



DAHALLIA_B

Art. 10-15

Questo tavolino dal design raffinato e linee pulite è un complemento di arredo capace di integrarsi con diversi stili di arredamento.

This coffee table with a refined design and clean lines is a furnishing accessory capable of integrating with different furnishing styles.

COLORE STRUTTURA STANDARD - STANDARD STRUCTURE COLOR



Bronzo
Metallizzato



Rame
Metallizzato



Alluminio
Goffrato



Avorio
Opaco



Beige
Grigio



Nero
Bucciato



Bianco
Bucciato

Art. 10-15-01

€ 598,00

Base **Ø 45 cm** con massima apertura **Ø 62 cm**

Struttura in acciaio alta **40 cm**

Colore standard

Top tavolo escluso

Base **Ø 45 cm** with maximum opening **Ø 62 cm**

Steel structure **40 cm** high

Standard color

Table top not included

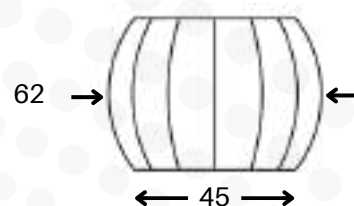

Forme e dimensioni top possibili



min 65 / max 120 cm



FINITURE TOP TAVOLO PAG. 133 - PREZZI TOP TAVOLO PAG. 153

TABLE TOP FINISHES PAG. 133 - TABLE TOP PRICES PAG. 153



CALLA_B

Art. 10-20

Con la sua struttura ad archi, questo tavolino racchiude una bellezza semplice che cattura immediatamente l'attenzione. Un esempio perfetto di come la semplicità possa essere sinonimo di sofisticatezza.

With its arched structure, this coffee table has a simple beauty that immediately catches the eye. A perfect example of how simplicity can be synonymous with sophistication.

COLORE STRUTTURA STANDARD - STANDARD STRUCTURE COLOR



Bronzo
Metallizzato



Rame
Metallizzato



Alluminio
Goffrato



Avorio
Opaco



Beige
Grigio

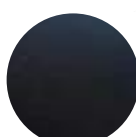

Nero
Bucciato



Bianco
Bucciato

Art. 10-20-01

€ 562,00

Base Ø 45 cm con minima apertura Ø 22.5 cm
Struttura in acciaio alta 40 cm
Colore standard
Top tavolo escluso

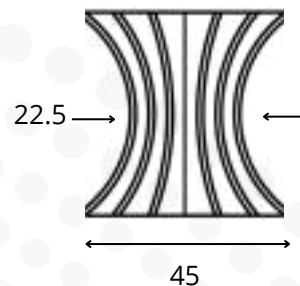

Base Ø 45 cm with minimum opening Ø 22.5 cm
Steel structure 40 cm high
Standard color
Table top not included

Forme e dimensioni top possibili



min 50 / max 90 cm



FINITURE TOP TAVOLO PAG. 133 - PREZZI TOP TAVOLO PAG. 153
TABLE TOP FINISHES PAG. 133 - TABLE TOP PRICES PAG. 153



IRIS_B

Art. 10-30

Un tavolino con un'unica base conica rappresenta una perfetta sintesi tra semplicità senza tempo e innovazione moderna. La forma conica, elegante e minimalista, non solo offre stabilità strutturale ma diventa anche un elemento di design distintivo che cattura l'attenzione senza risultare eccessivo.

A coffee table with a single conical base represents a perfect synthesis between timeless simplicity and modern innovation. The elegant and minimalist conical shape not only offers structural stability but also becomes a distinctive design element that captures attention without being excessive.

COLORE STRUTTURA STANDARD - STANDARD STRUCTURE COLOR



Bronzo
Metallizzato



Rame
Metallizzato



Alluminio
Goffrato



Avorio
Opaco



Beige
Grigio

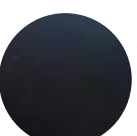

Nero
Bucciato



Bianco
Bucciato

Art. 10-30-01

€ 336,00

Base Ø 31 cm con minima apertura Ø 15 cm
Struttura in acciaio alta 45 cm
Colore standard
Top tavolo escluso

Base Ø 31 cm with minimum opening Ø 15 cm
Steel structure 45 cm high
Standard color
Table top not included

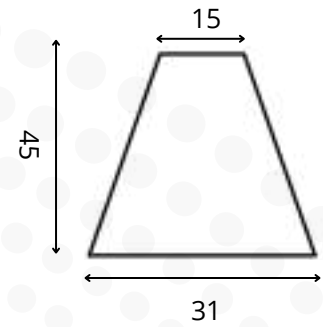

Forme e dimensioni top possibili



min 50 / max 80 cm



FINITURE TOP TAVOLO PAG. 133 - PREZZI TOP TAVOLO PAG. 153
TABLE TOP FINISHES PAG. 133 - TABLE TOP PRICES PAG. 153



STEM_B

Art. 10-36

Un unico cilindro di legno può diventare un elemento centrale perfetto per ottenere uno stile shabby chic che sia al contempo elegante e rustico, mentre la semplicità della forma cilindrica gli dona un senso di armonia.

A single wooden cylinder can become a perfect central element to achieve a shabby chic style that is both elegant and rustic, while the simplicity of the cylindrical shape gives it a sense of harmony.

COLORE STRUTTURA STANDARD - STANDARD STRUCTURE COLOR



Bronzo
Metallizzato



Rame
Metallizzato



Alluminio
Goffrato



Avorio
Opaco



Beige
Grigio



Nero
Bucciato



Bianco
Bucciato

Art. 10-36-01

€ 1.182,00

Base **Ø 50 cm**
Struttura in ferro alta **45 cm** rivestita con listelli di legno
Colore standard
Top tavolo escluso

Base **Ø 50 cm**
Iron structure **45 cm** high covered with wooden slats
Standard color
Table top not included

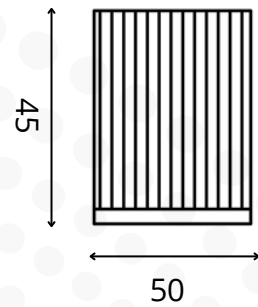

Forme e dimensioni top possibili



min 50 / max 100 cm



FINITURE TOP TAVOLO PAG. 133 - PREZZI TOP TAVOLO PAG. 153
TABLE TOP FINISHES PAG. 133 - TABLE TOP PRICES PAG. 153



VIOLET

Art. 10-52

Questo tavolino rappresenta un complemento di arredo versatile e di classe per chi cerca stabilità senza rinunciare al design raffinato. La sua struttura incrociata dei piedi non solo garantisce una solida base, ma aggiunge anche un tocco di sofisticatezza all'arredamento.

This coffee table is a versatile and classy piece of furniture for those seeking stability without sacrificing refined design. Its crossed structure of the feet not only ensures a solid base, but also adds a touch of sophistication to the decor.

COLORE STRUTTURA STANDARD - STANDARD STRUCTURE COLOR



Bronzo
Metallizzato



Rame
Metallizzato



Alluminio
Goffrato



Avorio
Opaco



Beige
Grigio



Nero
Bucciato



Bianco
Bucciato

Art. 10-52-01

€ 204,00

Base **60x60 cm**
Struttura in ferro alta **45 cm**
Colore standard
Top tavolo escluso

Base **60x60 cm**
Iron structure **45 cm** high
Standard color
Table top not included

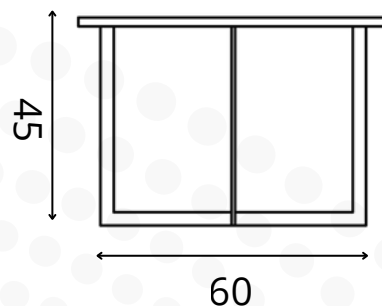

Forme e dimensioni top possibili



min 65 / max 80 cm



FINITURE TOP TAVOLO PAG. 133 - PREZZI TOP TAVOLO PAG. 153
TABLE TOP FINISHES PAG. 133 - TABLE TOP PRICES PAG. 153



ROSE

Art. 10-50

Questo tipo di tavolino dalla forma circolare permette di creare un punto focale armonioso e fluido all'interno di qualsiasi ambiente, facilitando la conversazione e la convivialità. Versatile e raffinato è capace di arricchire qualsiasi spazio con un tocco di eleganza discreta.

This type of circular coffee table allows you to create a harmonious and fluid focal point within any environment, facilitating conversation and conviviality. Versatile and refined, it is capable of enriching any space with a touch of discreet elegance.

COLORE STRUTTURA STANDARD - STANDARD STRUCTURE COLOR



Bronzo
Metallizzato



Rame
Metallizzato



Alluminio
Goffrato



Avorio
Opaco



Beige
Grigio

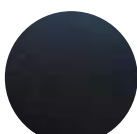

Nero
Bucciato



Bianco
Bucciato

Art. 10-50-01**€ 419,00**Base **Ø 50 cm**Struttura in acciaio alta **40 cm** per tavolo fisso

Colore standard

Top tavolo escluso

Base **Ø 50 cm**Steel structure **40 cm** high steel structure for fixed table

Standard color

Table top not included

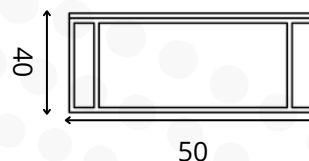
Forme e dimensioni top possibili

50 cm

Art. 10-50-02**€ 498,00**Base **Ø 80 cm**Struttura in acciaio alta **40 cm** per tavolo fisso

Colore standard

Top tavolo escluso

Base **Ø 80 cm**Steel structure **40 cm** high steel structure for fixed table

Standard color

Table top not included

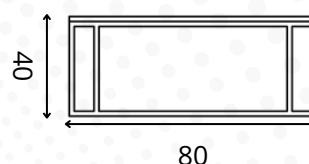
Forme e dimensioni top possibili

80 cm

Art. 10-50-03**€ 602,00**Base **Ø 100 cm**Struttura in acciaio alta **40 cm** per tavolo fisso

Colore standard

Top tavolo escluso

Base **Ø 100 cm**Steel structure **40 cm** high steel structure for fixed table

Standard color

Table top not included

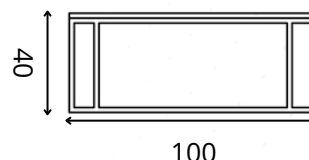
Forme e dimensioni top possibili

100 cm



ROSE



LEAF

Art. 10-51

Questo complemento di arredo con doppio appoggio, è versatile e funzionale, combinando discrezione e modernità in un unico design. Le linee pulite e minimaliste si integrano perfettamente in un contesto contemporaneo, assicurando una presenza discreta ed elegante.

This piece of furniture with double support is versatile and functional, combining discretion and modernity in a single design. The clean and minimalist lines integrate perfectly into a contemporary context, ensuring a discreet and elegant presence.

COLORE STRUTTURA STANDARD - STANDARD STRUCTURE COLOR



Bronzo
Metallizzato



Rame
Metallizzato



Alluminio
Goffrato



Avorio
Opaco



Beige
Grigio

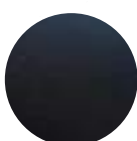

Nero
Bucciato



Bianco
Bucciato

Art. 10-51-01**€ 718,00****Base 60X60 cm**Struttura in acciaio alta **40 cm** con cornice h. 3 cm

Colore standard

Top tavolo escluso

Base 60X60 cmSteel structure **40 cm** high with frame h. 3 cm

Standard color

Table top not included

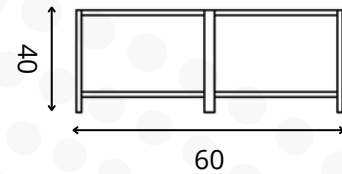
Forme e dimensioni top possibili**Art. 10-51-02****€ 876,00****Base 80X80 cm**Struttura in acciaio alta **40 cm** con cornice h. 3 cm

Colore standard

Top tavolo escluso

Base 80X80 cmSteel structure **40 cm** high with frame h. 3 cm

Standard color

Table top not included

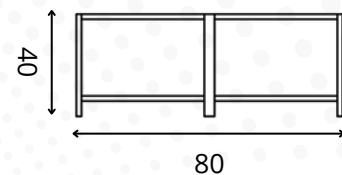
Forme e dimensioni top possibili**Art. 10-51-03****€ 1.017,00****Base 100X100 cm**Struttura in acciaio alta **40 cm** con cornice h. 3 cm

Colore standard

Top tavolo escluso

Base 100x100 cmSteel structure **40 cm** high with frame h. 3 cm

Standard color

Table top not included

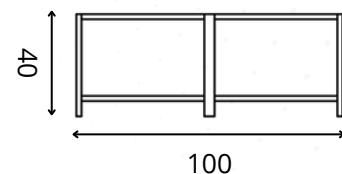
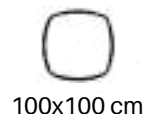
Forme e dimensioni top possibili



LEAF



STONE

Art. 10-60

Questo tavolino di solo marmo è unico nel suo genere perché unisce la ricercatezza del materiale con l'eleganza delle linee. Rifinito con cura artigianale, questo complemento di arredo rappresenta una perfetta fusione tra tradizione e modernità, non solo è funzionale, ma anche un'opera d'arte che cattura l'attenzione e arricchisce lo spazio.

This marble-only coffee table is one of a kind because it combines the refinement of the material with the elegance of the lines. Finished with artisanal care, this piece of furniture represents a perfect fusion between tradition and modernity, not only is it functional, but also a work of art that captures attention and enriches the space.

Art. 10-60-01

Tavolo Ø 50 cm - altezza 50 cm per tavolo fisso
Colore marmo naturale categorie M1-M2-M3-M4 o Agglomerato Terrazzo T1

Table Ø 50 cm - height 50 cm for fixed table
Marbre color categoris M1-M2-M3-M4 or Agglomerate Terrazzo T1

Struttura e piano in marmo naturale M1 Structure and top in natural marble M1	-----	€ 1.100,00
Struttura e piano in marmo naturale M2 o T1 Structure and top in natural marble M2 or T1	-----	€ 1.250,00
Struttura e piano in marmo naturale M3 Structure and top in natural marble M3	-----	€ 1.550,00
Struttura e piano in marmo naturale M4 Structure and top in natural marble M4	-----	€ 1.750,00

Art. 10-60-02

Tavolo Ø 80/90 cm - altezza 40 cm per tavolo fisso
Colore marmo naturale categorie M1-M2-M3-M4 o Agglomerato Terrazzo T1

Table Ø 80/90 cm - height 40 cm for fixed table
Marbre color categoris M1-M2-M3-M4 or Agglomerate Terrazzo T1

Struttura e piano in marmo naturale M1 Structure and top in natural marble M1	-----	€ 1.300,00
Struttura e piano in marmo naturale M2 o T1 Structure and top in natural marble M2 or T1	-----	€ 1.500,00
Struttura e piano in marmo naturale M3 Structure and top in natural marble M3	-----	€ 1.900,00
Struttura e piano in marmo naturale M4 Structure and top in natural marble M4	-----	€ 2.100,00

Art. 10-60-03

Tavolo 95x60 cm / 105x65 cm - altezza 40 cm per tavolo fisso
Colore marmo naturale categorie M1-M2-M3-M4 o Agglomerato Terrazzo T1

Table 95x60 cm / 105x65 cm - height 40 cm for fixed table
Marbre color categoris M1-M2-M3-M4 or Agglomerate Terrazzo T1

Struttura e piano in marmo naturale M1 Structure and top in natural marble M1	-----	€ 1.200,00
Struttura e piano in marmo naturale M2 o T1 Structure and top in natural marble M2 or T1	-----	€ 1.300,00
Struttura e piano in marmo naturale M3 Structure and top in natural marble M3	-----	€ 1.600,00
Struttura e piano in marmo naturale M4 Structure and top in natural marble M4	-----	€ 1.900,00

COLORI MARMO PAG. 135/136 - COLORI AGG. TERRAZZO PAG. 134
MARBLE COLORS PAG. 135/136 - AGG. TERRAZZO COLORS PAG. 134



STONE



CUBE

Art. 10-65

Questo tavolino, completamente realizzato in ceramica, rappresenta un esempio impeccabile di design raffinato e artigianale. Il suo stile cattura immediatamente l'attenzione, combinando una presenza importante con un'eleganza sobria e sofisticata. Ogni dettaglio è studiato per conferire al tavolino una bellezza che unisce arte e praticità.

This coffee table, made entirely of ceramic, is an impeccable example of refined and artisanal design. Its style immediately captures attention, combining an important presence with a sober and sophisticated elegance. Every detail is designed to give the coffee table a beauty that combines art and practicality.

Art. 10-65-01

Tavolo **30x30 cm / 50x50 cm** - altezza **60 cm** per tavolo fisso

Colore ceramica categorie C1-C2-C3

Table **30x30 cm / 50x50 cm** - height **60 cm** for fixed table

Ceramic color categoris C1-C2-C3

Struttura e piano in ceramica C1
Structure and top in ceramic C1 ----- **€ 1.100,00**

Struttura e piano in ceramica C2
Structure and top in ceramic C2 ----- **€ 1.200,00**

Struttura e piano in ceramica C3
Structure and top in ceramic C3 ----- **€ 1.400,00**

Art. 10-65-02

Tavolo **60x40 cm / 80x30 cm** - altezza **30 cm** per tavolo fisso

Colore ceramica categorie C1-C2-C3

Table **60x40 cm / 80x30 cm** - height **30 cm** for fixed table

Ceramic color categoris C1-C2-C3

Struttura e piano in ceramica C1
Structure and top in ceramic C1 ----- **€ 1.190,00**

Struttura e piano in ceramica C2
Structure and top in ceramic C2 ----- **€ 1.250,00**

Struttura e piano in ceramica C3
Structure and top in ceramic C3 ----- **€ 1.550,00**

Art. 10-65-03

Tavolo **60x40 cm / 80x30 cm** - altezza **40 cm** per tavolo fisso

Colore ceramica categorie C1-C2-C3

Table **60x40 cm / 80x30 cm** - height **40 cm** for fixed table

Ceramic color categoris C1-C2-C3

Struttura e piano in ceramica C1
Structure and top in ceramic C1 ----- **€ 1.190,00**

Struttura e piano in ceramica C2
Structure and top in ceramic C2 ----- **€ 1.250,00**

Struttura e piano in ceramica C3
Structure and top in ceramic C3 ----- **€ 1.550,00**



CUBE



CORNER

Art. 10-70

Un tavolino unico nel suo genere, elegante e senza tempo, interamente fatto a mano con una cura e una precisione artigianale, estremamente adattabile a qualsiasi ambiente, grazie alla sua versatilità compositiva sia nella disposizione che nella scelta dei materiali.

A one-of-a-kind coffee table, elegant and timeless, entirely handmade with artisanal care and precision, extremely adaptable to any environment, thanks to its compositional versatility both in the arrangement and in the choice of materials.

Art. 10-70-01

Tavolo **45x45 cm** - altezza **35 cm** per tavolo fisso

Colore marmo naturale categorie M1-M2-M3-M4 o Agglomerato Terrazzo T1

Table **45x45 cm** - height **35 cm** for fixed table

Marbre color categoris M1-M2-M3-M4 or Agglomerate Terrazzo T1

Struttura e piano in marmo naturale M1
Structure and top in natural marble M1 ----- **€ 880,00**

Struttura e piano in marmo naturale M2 o T1
Structure and top in natural marble M2 or T1 ----- **€ 970,00**

Struttura e piano in marmo naturale M3
Structure and top in natural marble M3 ----- **€ 1.230,00**

Struttura e piano in marmo naturale M4
Structure and top in natural marble M4 ----- **€ 1.350,00**

Art. 10-70-02

Tavolo **60x60 cm** - altezza **40 cm** per tavolo fisso

Colore marmo naturale categorie M1-M2-M3-M4 o Agglomerato Terrazzo T1

Table **60x60 cm** - height **40 cm** for fixed table

Marbre color categoris M1-M2-M3-M4 or Agglomerate Terrazzo T1

Struttura e piano in marmo naturale M1
Structure and top in natural marble M1 ----- **€ 990,00**

Struttura e piano in marmo naturale M2 o T1
Structure and top in natural marble M2 or T1 ----- **€ 1.250,00**

Struttura e piano in marmo naturale M3
Structure and top in natural marble M3 ----- **€ 1.400,00**

Struttura e piano in marmo naturale M4
Structure and top in natural marble M4 ----- **€ 1.580,00**



CORNER



TRENDY

Art. 10-75

Un tavolino in ceramica caratterizzato da forme squadrate, realizzato interamente a mano e dal design unico ed elegante. Il gioco di dimensioni e altezze rende questo complemento di arredo il fulcro del vostro spazio, unendo modernità e raffinatezza.

A ceramic coffee table characterized by square shapes, entirely handmade and with a unique and elegant design. The play of dimensions and heights makes this furnishing accessory the fulcrum of your space, combining modernity and refinement.

Art. 10-75-01

Tavolo **60x60 cm** - altezza **40 cm** per tavolo fisso
Colore ceramica categorie C1-C2-C3

Table **60x60 cm** - height **40 cm** for fixed table
Ceramic color categoris C1-C2-C3

Struttura e piano in ceramica C1
Structure and top in ceramic C1 ----- **€ 1.850,00**

Struttura e piano in ceramica C2
Structure and top in ceramic C2 ----- **€ 1.950,00**

Struttura e piano in ceramica C3
Structure and top in ceramic C3 ----- **€ 2.150,00**

Art. 10-75-02

Tavolo **100x50 cm** - altezza **40 cm** per tavolo fisso
Colore ceramica categorie C1-C2-C3

Table **100x50 cm** - height **40 cm** for fixed table
Ceramic color categoris C1-C2-C3

Struttura e piano in ceramica C1
Structure and top in ceramic C1 ----- **€ 2.300,00**

Struttura e piano in ceramica C2
Structure and top in ceramic C2 ----- **€ 2.400,00**

Struttura e piano in ceramica C3
Structure and top in ceramic C3 ----- **€ 2.700,00**

Art. 10-75-03

Tavolo **120x60 cm** - altezza **40 cm** per tavolo fisso
Colore ceramica categorie C1-C2-C3

Table **120x60 cm** - height **40 cm** for fixed table
Ceramic color categoris C1-C2-C3

Struttura e piano in ceramica C1
Structure and top in ceramic C1 ----- **€ 2.400,00**

Struttura e piano in ceramica C2
Structure and top in ceramic C2 ----- **€ 2.500,00**

Struttura e piano in ceramica C3
Structure and top in ceramic C3 ----- **€ 2.900,00**



TRENDY





Sedie Chairs

2025

Maple art. 20-15-01

Sedia imbottita con struttura in legno di faggio tinto
Upholstered chair with stained beech wood frame

Tessuti Seduta cat. A - B
Seat Fabrics cat. A - B € 968,00

Tessuti Seduta cat. C
Seat Fabrics cat. C € 872,00

Puntale galvanizzato oro
Gold plated tip € 126,00

Scegli il tuo stile - Choose your style

Colori Struttura - essenze legno sedie
Structure Colors - Wood essences chairspag. 145

Colori Seduta e Schienale - tessuti sedie
Seat and Backrest Colors - Chair Fabrics.....pag. 146 - 150

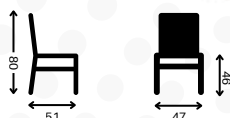

Maple Armchair art. 20-15-02

Poltroncina imbottita struttura in legno di faggio tinto
Padded armchair with stained beech wood frame

Tessuti Seduta cat. A - B
Seat Fabrics cat. A - B € 1.100,00

Tessuti Seduta cat. C
Seat Fabrics cat. C € 990,00

Puntale galvanizzato oro
Gold plated tip € 126,00

Scegli il tuo stile - Choose your style

Colori Struttura - essenze legno sedie
Structure Colors - Wood essences chairspag. 145

Colori Seduta e Schienale - tessuti sedie
Seat and Backrest Colors - Chair Fabrics.....pag. 146 - 150

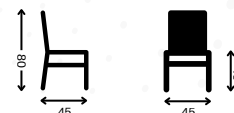

Maple Wood art. 20-15-03

Sedia con seduta imbottita, struttura e schienale in legno di faggio tinto.
Chair with padded seat, frame and backrest in stained beech wood.

Tessuti Seduta cat. A - B
Seat Fabrics cat. A - B € 1.100,00

Tessuti Seduta cat. C
Seat Fabrics cat. C € 990,00

Puntale galvanizzato oro
Gold plated tip € 126,00

Scegli il tuo stile - Choose your style

Colori Struttura e Schienale - essenze legno sedie
Structure and Backrest Colors - Wood essences chairspag. 145

Colori Seduta - tessuti sedie
Seat Colors - Chair Fabrics.....pag. 146 - 150

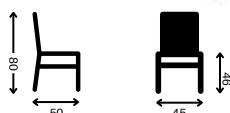

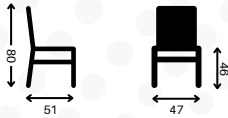

Maple Armchair Wood

art. 20-15-04

Poltroncina con seduta imbottita, struttura e schienale in legno di faggio tinto
Armchair with padded seat, frame and backrest in stained beech wood

Tessuti Seduta cat. A - B
Seat Fabrics cat. A - B **€ 1.098,00**

Tessuti Seduta cat. C
Seat Fabrics cat. C **€ 988,00**

Puntale galvanizzato oro
Gold plated tip **€ 126,00**

Scegli il tuo stile - Choose your style

Colori Struttura e Schienale - essenze legno sedie
Structure and Backrest Colors - Wood essences chairspag. 145

Colori Seduta - tessuti sedie
Seat Colors - Chair Fabrics.....pag. 146 - 150

Pine Wood

art. 20-20-01

Sedia con telaio in ferro verniciato, seduta e schienale in legno di faggio tinto
Chair with painted iron frame, seat and backrest in stained beech wood

Essenze Legno sedie
Wood Essenze chairs

€ 257,00

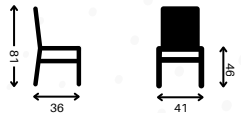

Scegli il tuo stile - Choose your style

Colori Struttura - Ral standard
Structure Colors - Ral standardpag. 144

Colori Seduta e Schienale - Essenze legno sedie
Seat and Backrest Colors - Wood essence chairs.....pag. 145

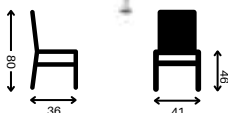

Pine

art. 20-20-02

Sedia con telaio in ferro verniciato, seduta e schienale imbottiti
Chair with painted iron frame, padded seat and back

Tessuti Seduta cat. A - B
Seat Fabrics cat. A - B **€ 438,00**

Tessuti Seduta cat. C
Seat Fabrics cat. C **€ 380,00**

Scegli il tuo stile - Choose your style

Colori Struttura - Ral standard
Structure Colors - Ral standardpag. 144

Colori Seduta e Schienale - tessuti sedie
Seat and Backrest Colors - Chair Fabrics.....pag. 146 - 150

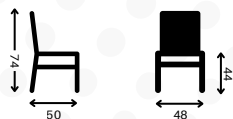

Poplar art. 20-25-01

Poltroncina con struttura in ferro verniciato e legno di faggio tinto, seduta e schienale imbottiti

Armchair with painted iron frame and stained beech wood, padded seat and backrest

Tessuti Seduta cat. A - B
Seat Fabrics cat. A - B **€ 920,00**

Tessuti Seduta cat. C
Seat Fabrics cat. C **€ 800,00**

Scegli il tuo stile - Choose your style

Colori Struttura - Ral standard
Structure Colors - Ral standardpag. 144

Colori Seduta - tessuti sedie
Seat Colors - Chair Fabrics.....pag. 146 - 150

Colori Schienale - Essenze legno sedie
Back Colors - Wood essence chairs.....pag. 145

Poplar Metal art. 20-25-02

Poltroncina con struttura, seduta e schienale in ferro verniciato
Armchair with structure, seat and backrest in painted iron

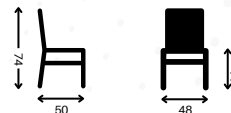

Ral Standard
Ral Standard **€ 406,00**

Scegli il tuo stile - Choose your style

Colori Struttura - Ral standard
Structure Colors - Ral standardpag. 144

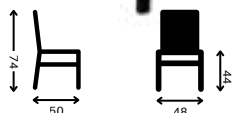

Poplar Soft art. 20-25-03

Sedia con struttura in ferro verniciato, seduta imbottita e schienale in legno di faggio tinto

Chair with painted iron frame, padded seat and backrest in stained beech wood

Tessuti Seduta cat. A - B
Seat Fabrics cat. A - B **€ 561,00**

Tessuti Seduta cat. C
Seat Fabrics cat. C **€ 488,00**

Scegli il tuo stile - Choose your style

Colori Struttura - Ral standard
Structure Colors - Ral standardpag. 144

Colori Seduta - tessuti sedie
Seat Colors - Chair Fabrics.....pag. 146 - 150

Colori Schienale - Essenze legno sedie
Back Colors - Wood essence chairs.....pag. 145



Poplar Metal Soft

art. 20-25-04

Poltroncina con struttura e schienale in ferro verniciato, seduta imbottita
Chair with painted iron frame, padded seat and backrest in stained beech wood

Tessuti Seduta cat. A - B
Seat Fabrics cat. A - B

€ 574,00

Tessuti Seduta cat. C
Seat Fabrics cat. C

€ 499,00

Scegli il tuo stile - Choose your style

Colori Struttura - Ral standard

Structure Colors - Ral standardpag.144

Colori Seduta - tessuti sedie

Seat Colors - Chair Fabrics.....pag. 146 - 150

Poplar Wood_B

art. 20-25-05

Poltroncina con struttura in ferro verniciato, seduta e schienale in legno di faggio tinto
Armchair with painted iron frame, seat and backrest in stained beech wood

Essenze legno sedie
Wood essence chairs

€ 414,00

Scegli il tuo stile - Choose your style

Colori Struttura - Ral standard

Structure Colors - Ral standardpag. 144

Colori Seduta e Schienale - Essenze legno sedie

Seat and Backrest Colors - Wood essence chairspag. 145

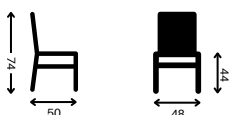
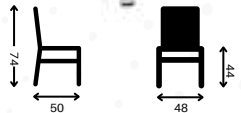

Poplar Wood

art. 20-25-06

Sedia con struttura in ferro verniciato, seduta e schienale in legno di faggio tinto
Chair with painted iron frame, seat and backrest in stained beech wood

Essenze legno sedie
Wood essence chairs

€ 378,00

Scegli il tuo stile - Choose your style

Colori Struttura - Ral standard

Structure Colors - Ral standardpag. 144

Colori Seduta e Schienale - Essenze legno sedie

Seat and Backrest Colors - Wood essence chairspag. 145

Palm art. 20-30-01

Sedia con struttura e schienale in legno di faggio tinto e seduta imbottita
Chair with structure and backrest in stained beech wood and padded seat

Tessuti Seduta cat. A - B
Seat Fabrics cat. A - B € 1.100,00

Tessuti Seduta cat. C
Seat Fabrics cat. C € 990,00

Puntale galvanizzato oro
Gold plated tip € 126,00

Scegli il tuo stile - Choose your style

Colori Struttura - Essenze legno sedie
Structure Colors - Wood essence chairs.....pag. 145

Colori Seduta - tessuti sedie
Seat Colors - Chair Fabrics.....pag. 146 - 150

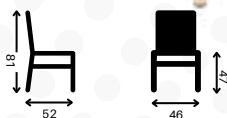

Palm Armchair art. 20-30-02

Poltroncina con struttura e schienale in legno di faggio tinto e seduta imbottita
Armchair with structure and backrest in stained beech wood and padded seat

Tessuti Seduta cat. A - B
Seat Fabrics cat. A - B € 1.073,00

Tessuti Seduta cat. C
Seat Fabrics cat. C € 966,00

Puntale galvanizzato oro
Gold plated tip € 126,00

Scegli il tuo stile - Choose your style

Colori Struttura - Essenze legno sedie
Structure Colors - Wood essence chairs.....pag. 145

Colori Seduta - tessuti sedie
Seat Colors - Chair Fabrics.....pag. 146 - 150

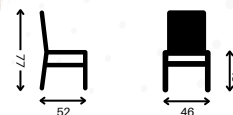

Palm Tissue art. 20-30-03

Poltroncina imbottita con gambe in legno di faggio tinto
Padded armchair with legs in stained beech wood

Tessuti Seduta cat. A - B
Seat Fabrics cat. A - B € 1.024,00

Tessuti Seduta cat. C
Seat Fabrics cat. C € 922,00

Puntale galvanizzato oro
Gold plated tip € 126,00

Scegli il tuo stile - Choose your style

Colori Struttura - Essenze legno sedie
Structure Colors - Wood essence chairs.....pag. 145

Colori Seduta e Schienale - tessuti sedie
Seat and Backrest Colors - Chair Fabrics.....pag. 146 - 150

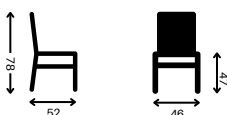



Willow

art. 20-35-01

Sedia imbottita con gambe in legno di faggio tinto
Upholstered chair with legs instained beech wood

Tessuti Seduta cat. A - B
Seat Fabrics cat. A - B **€ 968,00**

Tessuti Seduta cat. C
Seat Fabrics cat. C **€ 872,00**

Puntale galvanizzato oro
Gold plated tip **€ 126,00**

Scegli il tuo stile - Choose your style

Colori Struttura - Essenze legno sedie
Structure Colors - Wood essence chairs.....pag. 145

Colori Seduta Schienale - tessuti sedie
Seat and Backrest Colors - Chair Fabrics.....pag. 146 - 150

Willow Armchair

art. 20-35-02

Poltroncina imbottita con gambe in legno di faggio tinto
Padded armchair with legs in stained beech wood

Tessuti Seduta cat. A - B
Seat Fabrics cat. A - B **€ 1.188,00**

Tessuti Seduta cat. C
Seat Fabrics cat. C **€ 1.069,00**

Puntale galvanizzato oro
Gold plated tip **€ 126,00**

Scegli il tuo stile - Choose your style

Colori Struttura - Essenze legno sedie
Structure Colors - Wood essence chairs.....pag. 145

Colori Seduta e Schienale - tessuti sedie
Seat and Backrest Colors - Chair Fabrics.....pag. 146 - 150

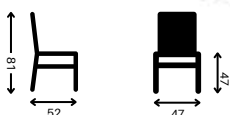
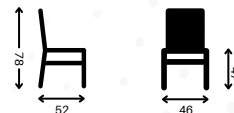

Medlar

art. 20-35-03

Poltroncina imbottita con gambe in legno di faggio tinto
Padded armchair with legs in stained beech wood

Tessuti Seduta cat. A - B
Seat Fabrics cat. A - B **€ 1.139,00**

Tessuti Seduta cat. C
Seat Fabrics cat. C **€ 1.025,00**

Puntale galvanizzato oro
Gold plated tip **€ 126,00**

Scegli il tuo stile - Choose your style

Colori Struttura - Essenze legno sedie
Structure Colors - Wood essence chairs.....pag. 145

Colori Seduta e Schienale - tessuti sedie
Seat and Backrest Colors - Chair Fabrics.....pag. 146 - 150



Cypress art. 20-40-01

Sedia con telaio in ferro verniciato seduta e schienale imbottiti
 Chair with painted iron frame padded seat and back

Tessuti Seduta cat. A - B
 Seat Fabrics cat. A - B **€ 521,00**

Tessuti Seduta cat. C
 Seat Fabrics cat. C **€ 453,00**

Scegli il tuo stile - Choose your style

Colori Struttura - Ral standard
 Structure Colors - Ral standard.....pag. 144

Colori Seduta e Schienale - tessuti sedie
 Seat and Backrest Colors - Chair Fabrics.....pag. 146 - 150

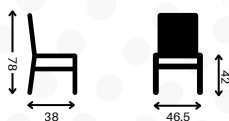

Cypress Alum art. 20-40-02

Sedia con telaio in ferro, seduta e schienale in alluminio verniciato
 con bottoni cromati/verniciati/galvanizzati

Chair with iron frame, seat and backrest in painted aluminum
 with buttons chromed/painted/galvanized

Ral Standard
 Ral Standard

€ 453,00

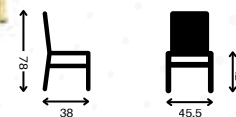

Scegli il tuo stile - Choose your style

Colori Struttura - Ral standard
 Structure Colors - Ral standard.....pag. 144

Cypress Wood art. 20-40-03

Sedia con telaio in ferro verniciato seduta e schienale in legno
 di faggio tinto

Chair with painted iron frame seat and backrest in stained beech wood

Seduta - essenze legno
 Sitting - Wood essences chairs **€ 327,00**

Scegli il tuo stile - Choose your style

Colori Struttura - Ral standard
 Structure Colors - Ral standard.....pag. 144

Colori Seduta e Schienale - Essenze legno sedie
 Seat and Backrest Colors - Wood essence chairs.....pag. 145

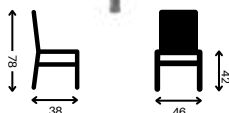



Cypress B

art. 20-40-04

Sedia con braccioli con telaio in ferro verniciato, seduta e schienale imbottiti
Armchair with painted iron frame, padded seat and backrest

Tessuti Seduta cat. A - B
Seat Fabrics cat. A - B

€ 616,00

Tessuti Seduta cat. C
Seat Fabrics cat. C

€ 536,00

Scegli il tuo stile - Choose your style

Colori Struttura - Ral standard

Structure Colors - Ral standard.....pag. 144

Colori Seduta e Schienale - tessuti sedie

Seat and Backrest Colors - Chair Fab.....pag. 146 - 150

Cypress Alum B

art. 20-40-05

Sedia con braccioli con telaio in ferro verniciato, schienale e seduta in alluminio con bottoni cromati/verniciati/galvanizzati

Armchair with painted iron frame, backrest and seat in aluminum with chromed/painted/galvanized buttons

Ral Standard
Ral Standard

€ 536,00

Scegli il tuo stile - Choose your style

Colori Struttura - Ral standard

Structure Colors - Ral standard.....pag. 144

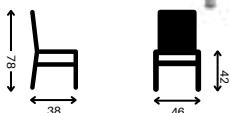

Cypress Wood B

art. 20-40-06

Sedia con braccioli con telaio in ferro verniciato, seduta e schienale in legno di faggio tinto

Armchair with painted iron frame, seat and backrest in stained beech wood

Seduta - essenze legno
Sitting - Wood essences chairs

€ 409,00

Scegli il tuo stile - Choose your style

Colori Struttura - Ral standard

Structure Colors - Ral standard.....pag. 144

Colori Seduta e Schienale - Essenze legno sedie

Seat and Backrest Colors - Wood essence chairs.....pag. 145

Mimosa art. 20-45-01

Sedia con telaio in ferro verniciato e seduta in legno di faggio tinto
Chair with painted iron frame and stained beech wood seat

Essenze legno sedie
Wood essence chairs

€ 294,00

Scegli il tuo stile - Choose your style

Colori Struttura - Ral standard
Structure Colors - Ral standardpag. 144

Colori Seduta - Essenze legno
Seat Colors - Wood essence chairs.....pag. 145

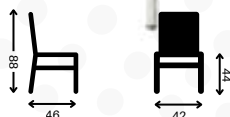

Mimosa Soft art. 20-45-02

Sedia con telaio in ferro verniciato e seduta imbottita
Chair with painted iron frame and padded seat

Tessuti Seduta cat. A - B
Seat Fabrics cat. A - B

€ 414,00

Tessuti Seduta cat. C
Seat Fabrics cat. C

€ 360,00

Scegli il tuo stile - Choose your style

Colori Struttura - Ral standard
Structure Colors - Ral standardpag. 144

Colori Seduta - Tessuti sedie
Seat Colors - Chair Fabrics.....pag. 146 - 150



Mimosa B art. 20-45-03

Sedia con braccioli con telaio in ferro verniciato e seduta in legno di faggio tinto
Armchair with painted iron frame and seat in stained beech wood

Essenze legno sedie
Wood essence chairs

€ 414,00

Scegli il tuo stile - Choose your style

Colori Struttura - Ral standard
Structure Colors - Ral standardpag. 144

Colori Seduta - Essenze legno sedie
Seat Colors - Wood essence chairs.....pag. 145

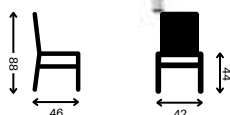



Mimosa Soft B

art. 20-45-04

Sedia con braccioli con telaio in ferro verniciato e seduta imbottita
Armchair with painted iron frame and padded seat

Tessuti Seduta cat. A - B
Seat Fabrics cat. A - B € 552,00

Tessuti Seduta cat. C
Seat Fabrics cat. C € 480,00

Scegli il tuo stile - Choose your style

Colori Struttura - Ral standard
Structure Colors - Ral standardpag. 144

Colori Seduta - Tessuti sedie
Seat Colors - Chair Fabrics.....pag. 146 - 150

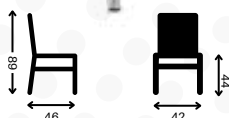

Ginger

art. 20-50-01

Sedia con telaio in ferro verniciato e seduta in legno di faggio tinto
Chair with painted iron frame and stained beech wood seat

Seduta - essenze legno
Sitting - Wood essences chairs

€ 276,00



Scegli il tuo stile - Choose your style

Colori Struttura - Ral standard
Structure Colors - Ral standardpag. 144

Colori Seduta - Essenze legno
Seat Colors - Wood essence chairs.....pag. 145

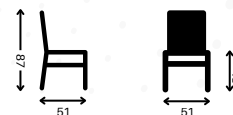

Opzione Puntale
Galvanizzato Oro



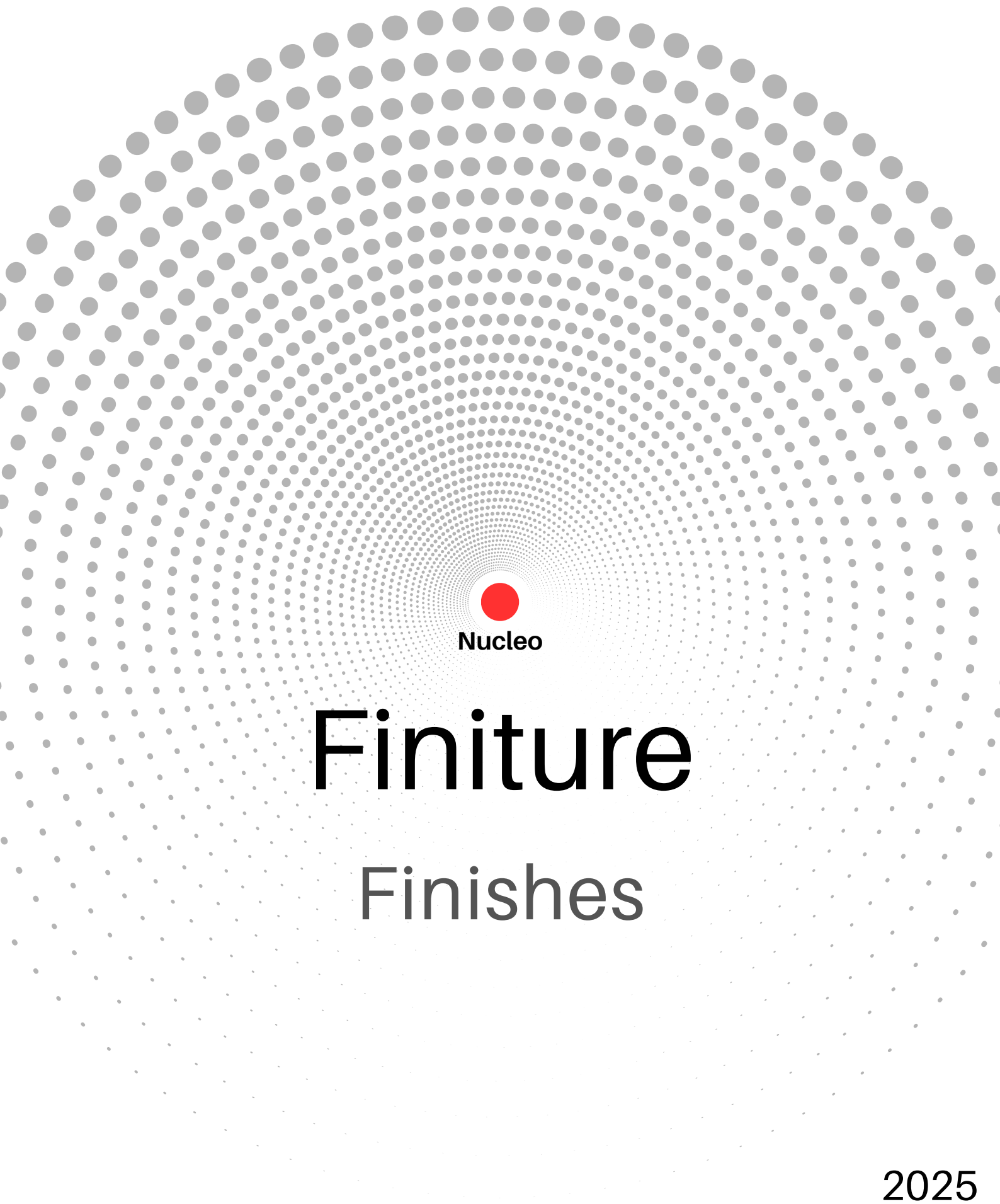

Nucleo

Finiture

Finishes

2025

AGGLOMERATO TERRAZZO

AGGLOMERATE TERRAZZO

Lucido o Opaco - Spessore 20 mm / Glossy or Matt - Thickness 20 mm

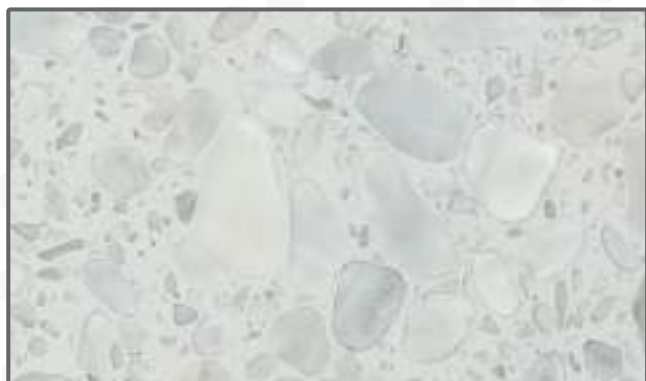

Palladio Bianco (T1)

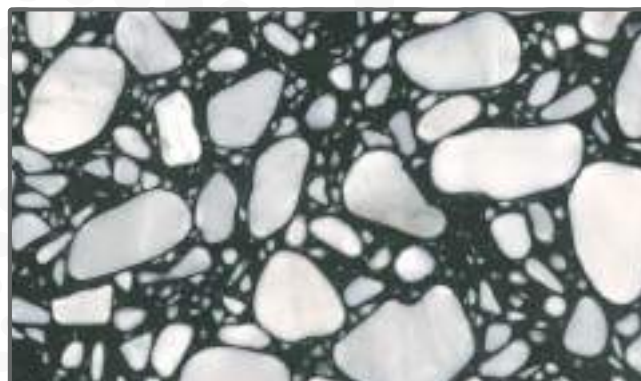

Palladio Nero (T1)



Arlecchino (T1)



Basel (T1)

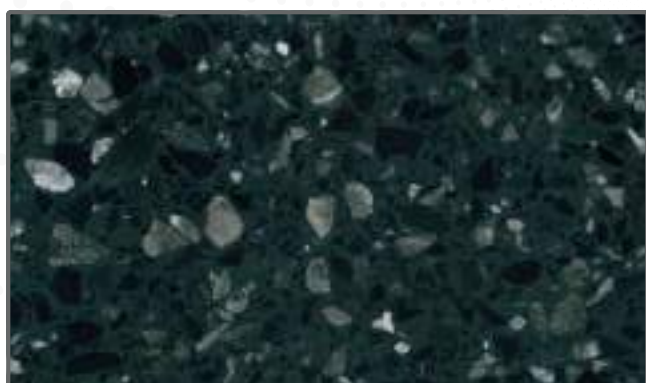

Millennium (T1)



Perlato (T1)

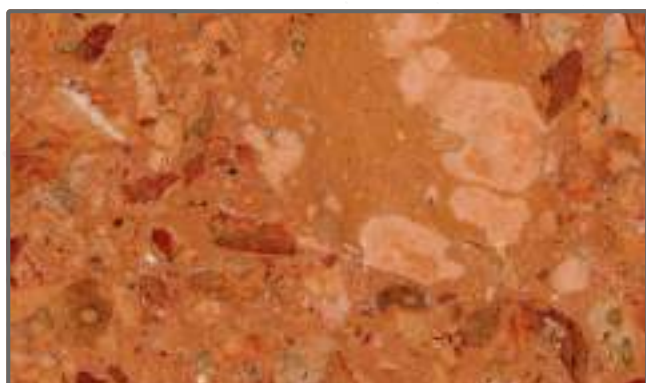

Rosso Asiago (T1)

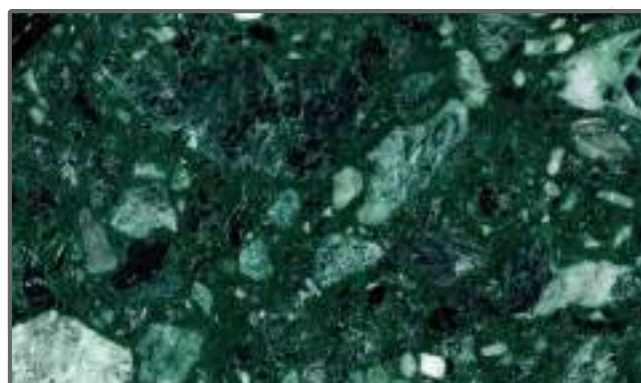

Verde Italia (T1)

Per tavoli massimo 260x120 cm o Ø120 cm

MARMO NATURALE NATURAL MARBLE

Lucido o Opaco - Spessore 20 mm / Glossy or Matt - Thickness 20 mm



Bianco Cristallino (M4)



Bianco di Carrara (M1)



Bianco Perla (M2)

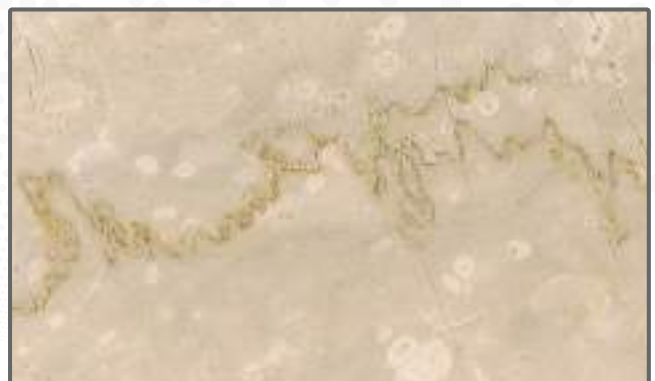

Botticino (M2)



Breccia Rosa (M3)



Calacatta (M4)



Daino Reale (M2)



Emperador Brown (M2)

MARMO NATURALE

NATURAL MARBLE

Lucido o Opaco - Spessore 20 mm / Glossy or Matt - Thickness 20 mm



Fior di Pesco (M3)



Nero Marquinia (M2)



Rosso Lepanto (M4)



Rosso Verona (M2)



Travertino Classico (M3)



Verde Alpi (M4)



Verde Guatemala (M2)



Arabescato (M4)

QUARZO LUCIDO

POLISHED QUARTZ

Spessore 20 mm / Thickness 20 mm

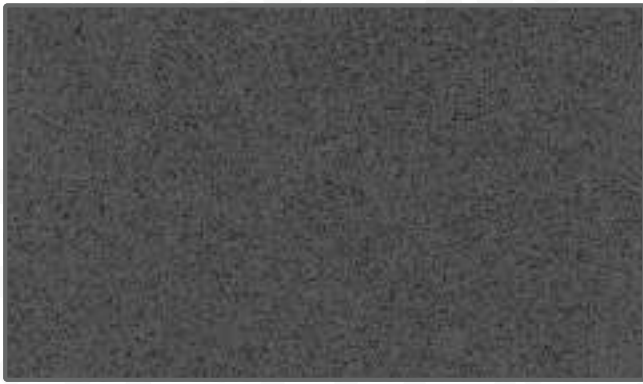

Antracite (Q1)



Bianco Assoluto (Q1)



Bianco Stellare (Q1)



Nero Assoluto (Q1)



Nero Stellare (Q1)



Noce (Q1)

QUARZO LUCIDO

POLISHED QUARTZ

Spessore 12 mm / Thickness 12 mm



Antracite (Q2)



Bianco Assoluto (Q3)



Bianco Stellare (Q3)



Grigio (Q2)

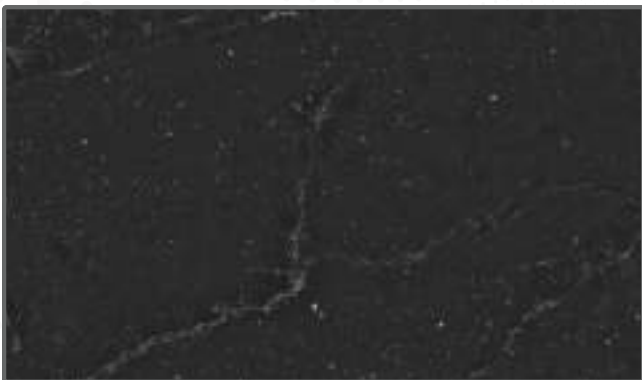

Romantic Ash (Q3)



Parisien Bleu (Q1)



SalePepe (Q2)

QUARZO OPACO MATT QUARTZ

Spessore 12 mm / Thickness 12 mm



Brass Relish (Q3)



Chateau Brown (Q1)



Eclectic Pearl (Q1)



Lime Delight (Q3)



Night Tebas (Q3)

CERAMICA OPACA

MATT CERAMIC

Spessore 12 mm / Thickness 12 mm



Ardesia Grigia (C1)



Ardesia Nera (C1)



Grafite (C1)



Statuario Bianco (C1)



Travertino Gold (C1)



Verde Alpi (C1)



Nero Marquinia (C1)

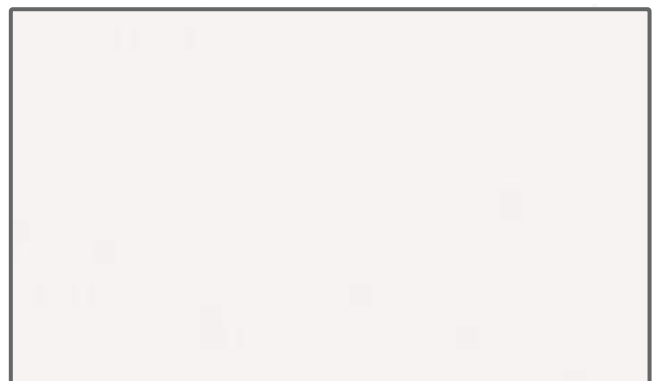

Bianco Naturale (C1)

CERAMICA LUCIDA

GLOSSY CERAMIC

Spessore 12 mm / Thickness 12 mm



Azzurro (C2)



Calacatta Oro (C2)



Nero Marquina (C2)



Port Laurent (C2)



Statuario Bianco (C2)

CERAMICA MATERICA OPACA MATT MATERIAL CERAMIC

Spessore 12 mm / Thickness 12 mm



Pietra di Cardoso Grigio (C3)



Pietra di Cardoso Nero (C3)



Pietra Piasentina Grigio (C3)



Porfido Marrone (C3)



Terra di Matera (C3)



Terra di Saturnia (C3)



Terra di Pompei (C3)



Ceppo di Gré Grigio (C3)

ESSENZE LEGNO

WOOD ESSENCES

Per basi tavolo in legno - Escluso modello Tulipano
For wooden table bases - Excluding Tulipano model



Naturale



Nero

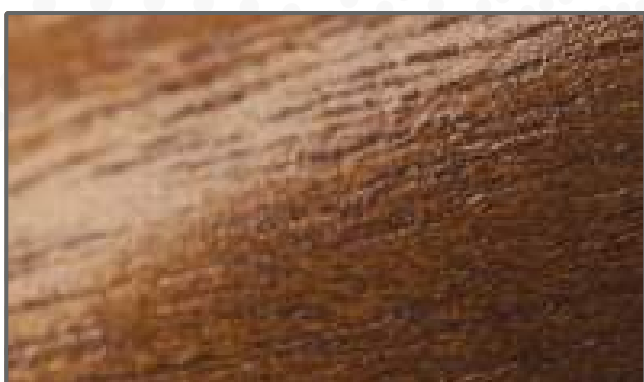

Noce Chiaro



Noce Scuro



Rovere

COLORI RAL RAL COLORS

Per tavoli e sedie in metallo - Escluso modello Tulipano
For metal tables and chairs - Excluding Tulipano model



Bronzo Metallizzato



Rame Metallizzato



Alluminio Goffrato



Avorio Opaco



Beige Grigio

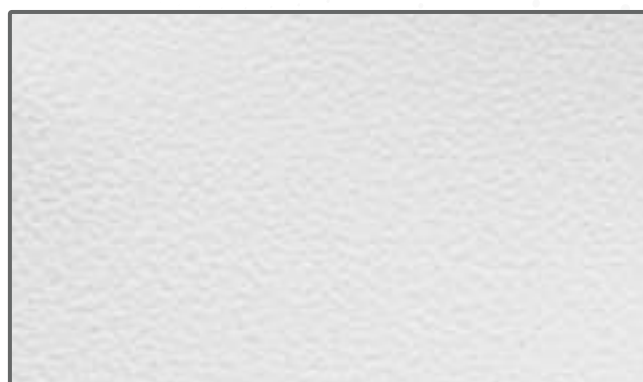

Bianco Bucciato



Nero Bucciato

ESSENZE LEGNO SEDIE

WOOD ESSENCES FOR CHAIRS



Bianco



Acero



Ciliegio Chiaro



Ciliegio Scuro



Mogano Chiaro



Mogano



Naturale



Nero



Noce Chiaro



Noce Scuro



Noce



Palissandro

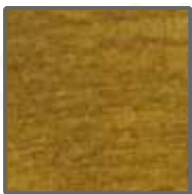

Rovere



Taupe

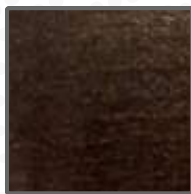

Wenge Rosso



Wenge

RIVESTIMENTI CAT.A

CAT.A COVERINGS

Cotone simil velluto

Velvet-like cotton



788-167



788-179



788-194



788-198

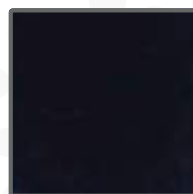

788-240



788-251



788-261



788-297

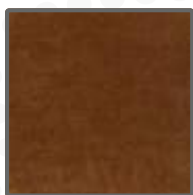

788-303

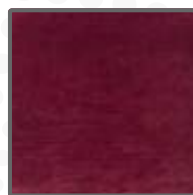

788-307



788-308

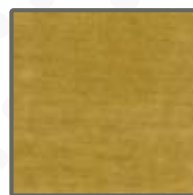

788-309

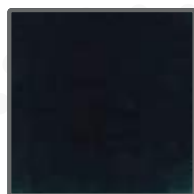

788-310



788-311



788-313



788-315

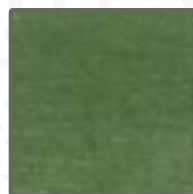

788-316



788-317



788-319



788-320



788-321

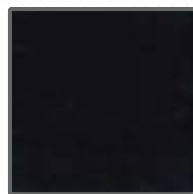

788-409



788-412



788-419



788-428



788-429



788-431

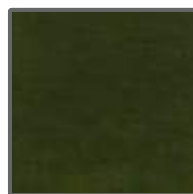

788-440

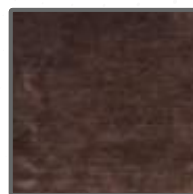

788-441



788-498



788-985

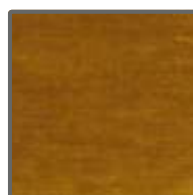

788-986



788-987



788-988

RIVESTIMENTI CAT.A

CAT.A COVERINGS

Cotone
Cotton



780-033



780-035



780-002



780-004



780-007



780-008



780-010



780-030



780-031

RIVESTIMENTI CAT.A

CAT.A COVERINGS

Cotone
Cotton



782-001



782-002



782-003



782-004



782-005



782-006



782-007



782-008



782-009



782-010



782-011

RIVESTIMENTI CAT.B

CAT.B COVERINGS

Cotone
Cotton

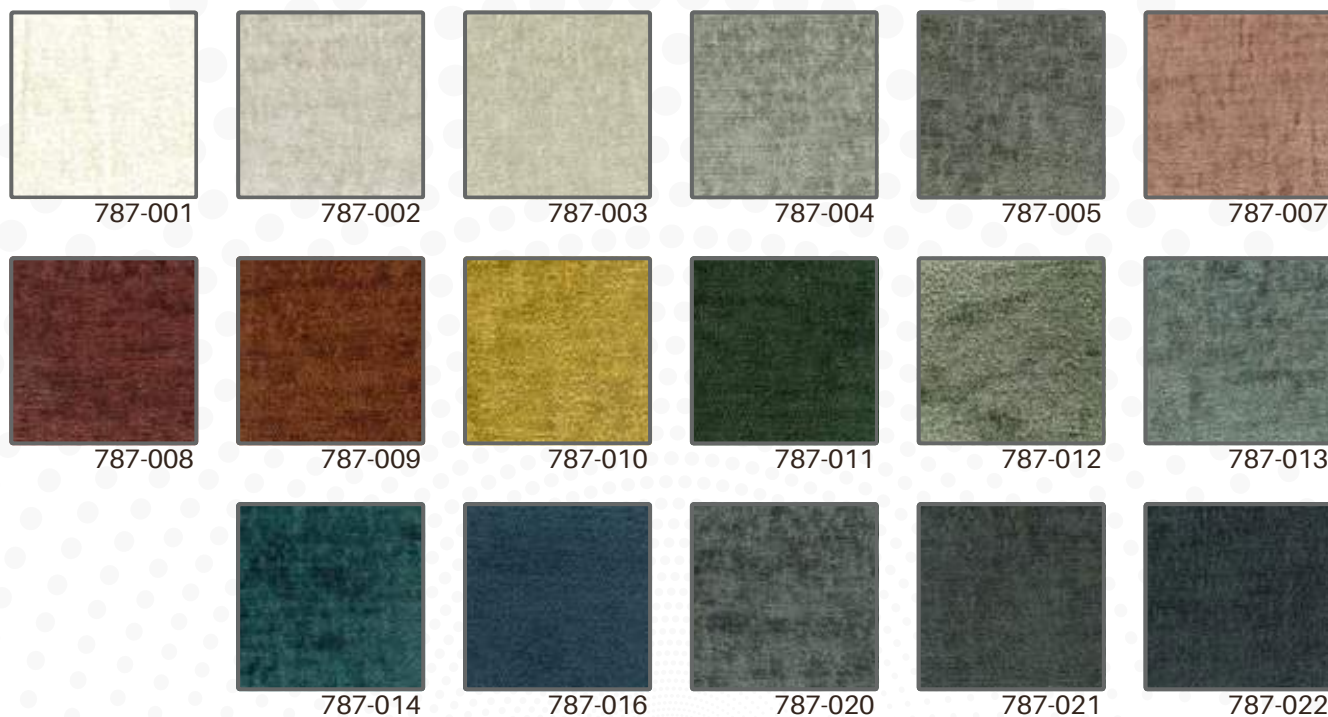

RIVESTIMENTI CAT.B

CAT.B COVERINGS

Cotone
Cotton

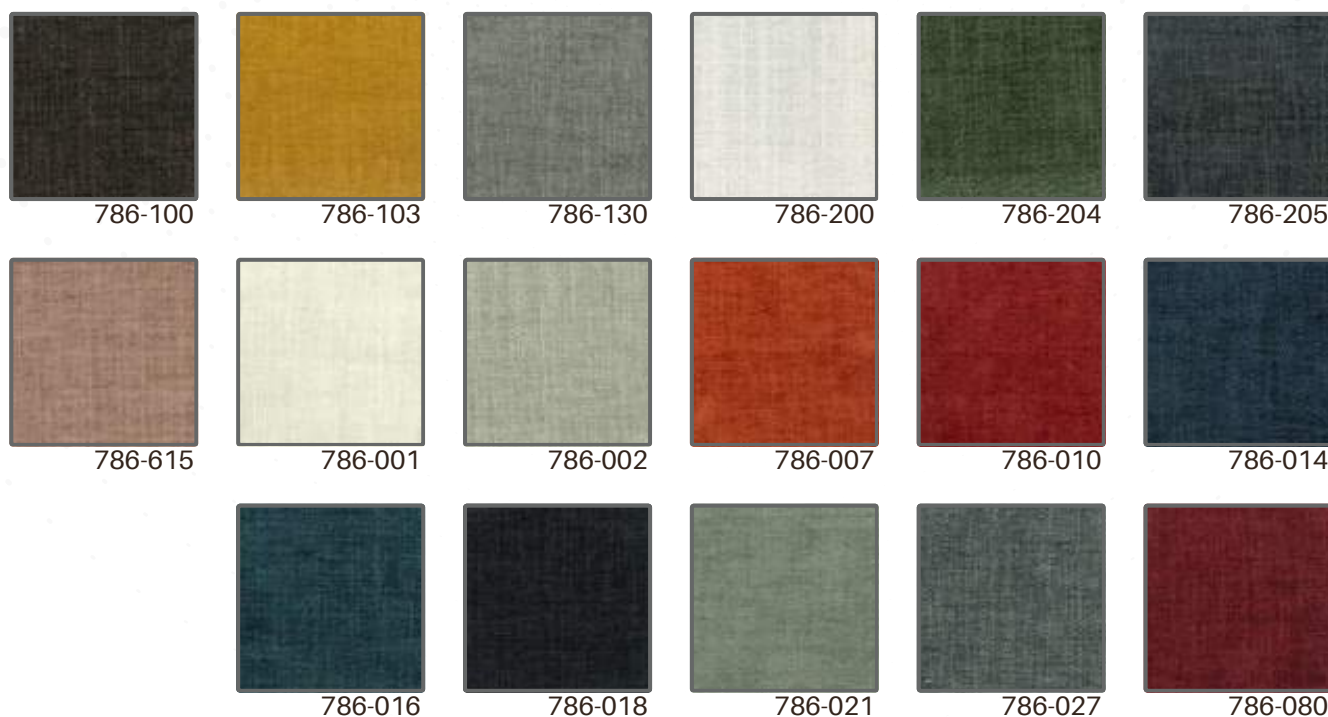

RIVESTIMENTI CAT.B

CAT.B COVERINGS

Cotone simil velluto
Velvet-like cotton

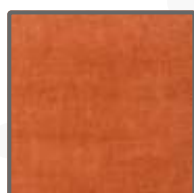

784-007



784-010



784-012



784-015



784-017



784-018



784-020



784-027



784-102



784-130

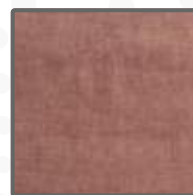

784-615



784-800

RIVESTIMENTI CAT.B

CAT.B COVERINGS

Cotone
Cotton



781-001



781-002



781-003



781-004



781-005



781-007



781-008



781-010

RIVESTIMENTI CAT.C

CAT.C COVERINGS

Similpelle Ignifuga
Fireproof Faux Leather



PROFILI TOP TAVOLO

TABLE TOP EDGES

MARMO NATURALE e AGGLOMERATO TERRAZZO
 NATURAL MARBLE and AGGLOMERATE TERRAZZO
 Spessore 20 mm - Thickness 20 mm
 LUCIDO o OPACO - GLOSSY or MATT

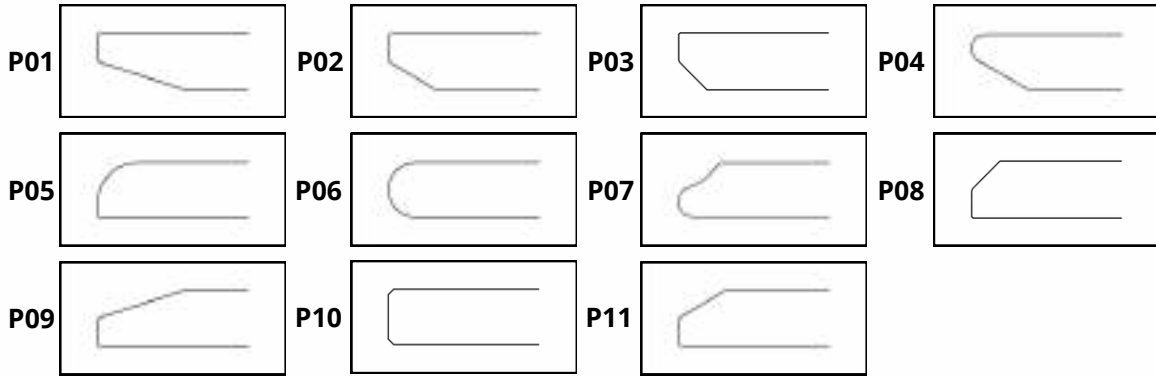

QUARZO - QUARTZ
 Spessore 20 mm - Thickness 20 mm
 LUCIDO - GLOSSY

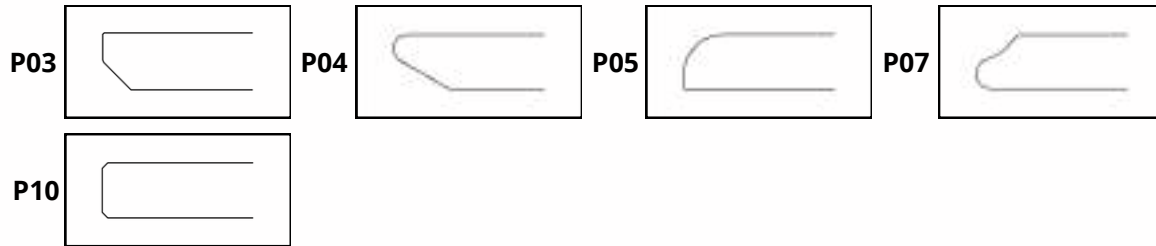

QUARZO - QUARTZ
 Spessore 12 mm - Thickness 12 mm
 LUCIDO - GLOSSY



CERAMICA - CERAMIC
 Spessore 12 mm - Thickness 12 mm
 LUCIDA o OPACA o MATERICA - GLOSSY or MATT or MATERIAL

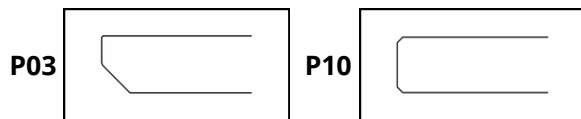





Listino Top

Top Price List

2025

MARMO NATURALE - NATURAL MARBLE

Lucido o Opaco / Glossy or Matt - Spessore 20 mm / Thickness 20 mm
(Profilo a scelta pag. 151 - Edge profile of your choice pag. 151)

BIANCO DI CARRARA (M1)	€ 750,00 / m ²
BIANCO PERLA BOTTICINO DAINO REALE EMPERADOR BROWN (M2) NERO MARQUINIA ROSSO VERONA VERDE GUATEMALA	€ 900,00 / m ²
BRECCIA ROSA FIOR DI PESCO (M3) TRAVERTINO CLASSICO	€ 1200,00 / m ²
ARABESCATO BIANCO CRISTALLINO (M4) CALACATTA ROSSO LEPANTO VERDE ALPI	€ 1400,00 / m ²

QUARZO LUCIDO - POLISHED QUARTZ

Spessore 20 mm / Thickness 20 mm
(Profilo a scelta pag. 151 - Edge profile of your choice pag. 151)

ANTRACITE BIANCO ASSOLUTO BIANCO STELLARE (Q1) NERO ASSOLUTO NERO STELLARE NOCE	€ 1400,00 / m ²
--	----------------------------

QUARZO LUCIDO o OPACO - POLISHED or MATT QUARTZ

Spessore 12 mm / Thickness 12 mm
(Profilo a scelta pag. 151 - Edge profile of your choice pag. 151)

CHATEAU BROWN ECLECTIC PEARL (Q1) PARISIEN BLEU	€ 1400,00 / m ²
ANTRACITE GRIGIO (Q2) SALEPEPE	€ 900,00 / m ²
BIANCO ASSOLUTO BIANCO STELLARE (Q3) BRASS RELISH LIME DELIGHT NIGHT TEBAS ROMANTIC ASH	€ 1200,00 / m ²

CERAMICA OPACA - MATT CERAMIC

Spessore 12 mm / Thickness 12 mm
(Profilo a scelta pag. 151 - Edge profile of your choice pag. 151)

ARDESIA GRIGIA
ARDESIA NERA
GRAFITE
STATUARIO BIANCO (C1)
TRAVERTINO GOLD
VERDE ALPI
NERO MARQUINIA
BIANCO NATURALE

€ 800,00 / m²

CERAMICA LUCIDA - GLOSSY CERAMIC

Spessore 12 mm / Thickness 12 mm
(Profilo a scelta pag. 151 - Edge profile of your choice pag. 151)

AZZURRO
CALACATTA ORO
NERO MARQUINIA
PORT LAURENT
STATUARIO BIANCO (C2)

€ 900,00 / m²

CERAMICA MATERICA OPACA - MATT MATERIAL CERAMIC

Spessore 12 mm / Thickness 12 mm
(Profilo a scelta pag. 151 - Edge profile of your choice pag. 151)

PIETRA DI CARDOSO GRIGIO
PIETRA DI CARDOSO NERO
PIETRA PIASENTINA GRIGIO
PORFIDO MARRONE (C3)
TERRA DI MATERA
TERRA DI POMPEI
TERRA DI SATURNIA
CEPPO DI GRÉ GRIGIO

€ 1200,00 / m²

AGGLOMERATO TERRAZZO - AGGLOMERATE TERRAZZO

Lucido o Opaco / Glossy or Matt - Spessore 20 mm / Thickness 20 mm
(Profilo a scelta pag. 92 - Edge profile of your choice pag. 92)

PALLADIO BIANCO
PALLADIO NERO
ARLECCHINO
BASEL
MILLENNIUM
PERLATO
ROSSO ASIAGO
VERDE ITALIA (T1)

€ 900,00 / m²

QUADRATURA MINIMA FATTURABILE: 0,40 m²

Esempi di
quadratura



ovale 200x80 cm = 1,6 m²

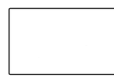

rettangolo 200x80 cm = 1,6 m²



diametro 120 cm = 1,44 m²



quadrato 120x120 cm = 1,44 m²



Tavolino STONE - pag. 108

Cura e Manutenzione

Per la pulizia ordinaria, utilizzare esclusivamente panni morbidi e spugne non abrasive, inumiditi con acqua e/o detersivi neutri. È fondamentale evitare di graffiare la superficie e di impiegare detersivi eccessivamente aggressivi con pH estremamente alto o basso.

Si raccomanda di evitare prodotti contenenti alcol, acetone, ammoniaca, cloro, solventi, composti acidi e basici, poiché potrebbero ristagnare e macchiare o corrodere la superficie.

Mantenere lontani solventi per unghie, ammoniaca o detersivi contenenti ammoniaca, sbiancanti, pennarelli indelebili, inchiostro, saponi oleosi, limone, vino, caffè e bevande.

Qualora una delle sostanze sopra elencate dovesse entrare in contatto con la superficie, risciacquare e asciugare immediatamente.

Evitare bruciature da sigarette e non posizionare sulla superficie oggetti molto caldi o abrasivi.

Infine, smaltire il mobile seguendo le modalità e le procedure stabilite dall'azienda comunale competente per lo smaltimento.

Care and Maintenance

For ordinary cleaning, use only soft cloths and non-abrasive sponges, moistened with water and/or neutral detergents. It is essential to avoid scratching the surface and using excessively aggressive detergents with extremely high or low pH.

It is recommended to avoid products containing alcohol, acetone, ammonia, chlorine, solvents, acidic and basic compounds, as they could stagnate and stain or corrode the surface.

Keep away nail polish removers, ammonia or detergents containing ammonia, whiteners, permanent markers, ink, oily soaps, lemon, wine, coffee and drinks.

If any of the substances listed above should come into contact with the surface, rinse and dry immediately.

Avoid cigarette burns and do not place very hot or abrasive objects on the surface.

Finally, dispose of the furniture following the methods and procedures established by the competent municipal waste disposal company.

Note

Tutti i prezzi di questo catalogo sono da intendersi IVA esclusa.

Per consegna di ordini inferiori a € 1.000,00 iva esclusa sarà addebitato un contributo di trasporto di € 50,00 iva esclusa.

Le commesse sono sempre soggette all'approvazione dell'azienda, la quale può accettarle tacitamente o rifiutarle espressamente per iscritto entro dieci giorni dal ricevimento.

È fondamentale effettuare un controllo del materiale al momento dello scarico. Eventuali difformità riscontrate, attribuibili a fasi successive all'imballaggio (come rotture, ammaccature o graffiature), devono essere contestate immediatamente al trasportatore e annotate sul documento di trasporto, per poi essere comunicate all'azienda.

Non saranno accettate contestazioni successive, eccetto nel caso di evidenti difetti di fabbricazione riscontrati nel materiale. In tal caso, l'azienda provvederà alla sostituzione dopo che un suo incaricato avrà esaminato il prodotto contestato e verificato il difetto.

Non sono consentiti resi senza preventiva autorizzazione da parte dell'azienda.

Si respingono tutte le contestazioni relative alla tonalità e all'intensità delle venature dei top in marmo, ceramica e legno, poiché tali variazioni sono intrinseche ai materiali e naturali per loro natura.

Le immagini delle finiture e dei colori presentati devono essere considerate puramente indicative.

La nostra azienda si riserva il diritto di apportare modifiche a parti e dettagli in qualsiasi momento e senza preavviso, qualora ciò si renda necessario per migliorare la funzionalità o l'estetica dei prodotti.

Note

All prices in this catalog are exclusive of VAT.

For delivery of orders under € 1,000.00 excluding VAT, a transport fee of € 50.00 excluding VAT will be charged.

Orders are always subject to the approval of the company, which can accept them tacitly or expressly reject them in writing within ten days of receipt.

It is essential to check the material upon unloading. Any discrepancies found, attributable to phases subsequent to packaging (such as breakages, dents or scratches), must be immediately contested to the carrier and noted on the transport document, and then communicated to the company.

Subsequent complaints will not be accepted, except in the case of obvious manufacturing defects found in the material. In this case, the company will replace the product after one of its representatives has examined the disputed product and verified the defect.

Returns are not permitted without prior authorization from the company.

All complaints relating to the shade and intensity of the grain of marble, ceramic and wood tops are rejected, as these variations are intrinsic to the materials and natural by their nature.

The images of the finishes and colors presented must be considered purely indicative.

Our company reserves the right to make changes to parts and details at any time and without notice, if this is necessary to improve the functionality or aesthetics of the products.

NUCLEO

I NOSTRI CONTATTI

Get in touch with Us!

 +39 051 827713

 info@nucleoarreda.it

 www.nucleoarreda.it

 [nucleo_arreda](https://www.instagram.com/nucleo_arreda)

 [nucleo](https://www.facebook.com/nucleo)



c/o Serra Marmi
Via L. Davia 9/F
San Giovanni in Persiceto, 40017
Bologna, Italy